



01
BATHROOM ACCESSORIES AND COMPLEMENTS
ACCESORIOS Y COMPLEMENTOS DE BAÑO

COSMIC

2023

CATALOGUE
CATÁLOGO





COSMIC

Stimulation, relaxation, comfort...
the bathroom reintroduces us to
ourselves through objects that
transcend the merely functional.

Activarse, relajarse, sentirse cómodo...
en el baño nos reencontramos con
nosotros mismos, a través de una
serie de objetos que trascienden lo
meramente funcional.





Bath Experiences



- 006 ACCESSORIES
ACCESORIOS
- 006 **Architect**
- 026 **Architect S**
- 040 **B-Smart**
- 048 **Bath Life**
- 060 **Belle**
- 074 **Black & White**
- 084 **Diabolo**
- 092 **Duo**
- 108 **Eda**
- 122 **Equilibrium**
- 134 **Extreme**
- 144 **Kubic**
- 160 **Kubic Class**
- 176 **Kubic Cool**
- 192 **Line**
- 200 **Logic**
- 216 **Metric**
- 230 **Micra**
- 242 **Minimalism**
- 252 **Project**
- 264 **Stick**
- 276 **The Grid**
- 286 **Urban**
- 298 **Windsor**



- 310 FREE STANDING ACCESSORIES
COMPLEMENTOS
- 310 **Geyser**
- 318 **Inside**
- 324 **Saku**



- 330 ESSENTIALS
- 332 **Shower soap dishes**
Jaboneras de ducha
- 338 **Waste bin**
Papeleras
- 342 **Magnifying mirror**
Espejos aumento
- 348 **Stools**
Taburetes
- 352 SPARE PARTS
RECAMBIOS
- 354 MATERIALS
MATERIALES
- 358 SALES CONDITIONS
CONDICIONES DE VENTA



Architect

Design by **Cosmic Studio**

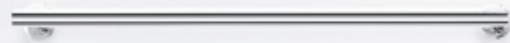





A multitude of pieces come out of architectonic forms that dominate with their resistance. A comprehensive collection of accessories with a timeless and elegant design.

De las formas arquitectónicas surgen multitud de piezas que destacan por su resistencia. Colección completa con un diseño atemporal y elegante.









Architect

Design by Cosmic Studio





DUAL SYSTEM / SISTEMA DUAL

Our updated Architect collection now includes a dual installation system for installing bathroom accessories with or without a drill. Smart-fix adhesive, designed exclusively for our firm, means that bathroom accessories can be installed without drilling holes in the wall.

La colección Architect presenta como novedad el sistema de instalación dual, que permite sujetar los accesorios de baño con y sin taladros. Con el adhesivo Smart-fix, elaborado en exclusiva para la firma, se facilita el montaje sin la necesidad de hacer agujeros en la pared.

FEATURES / CARACTERÍSTICAS

Easy installation: double pitch screw. Hidden attachments. Anti-corrosion.

Fácil instalación: tornillo de doble paso. Fijaciones ocultas. Anticorrosión.

Architect has successfully passed the high demanding tests of long last durability and resistance to extreme uses (static charge or impact testing) to assure long last durability of the product. All products come with 10 years warranty, except for waste bins and stools, which come with 3 years warranty.

Toda la gama Architect ha superado con éxito exigentes tests de durabilidad y resistencia a usos extremos (cargas estáticas o test de impacto), para asegurar una larga vida al producto. Todos los artículos tienen 10 años de garantía a excepción de las papeleras y los taburetes que tienen una garantía de 3 años.

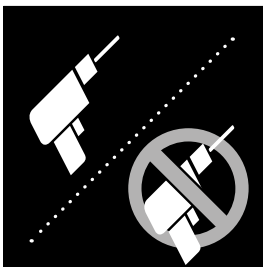

**SMART
FIX**

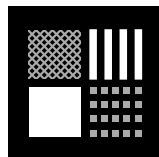

Works with different surfaces*

Efectivo en diferentes superficies*



Static load of 15 kg

Carga estática de 15 KG



Impact resistance

Resistente a impactos



Removable accessories

Accesorios removibles

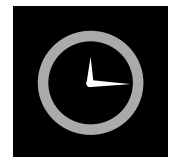

Quick, easy, silent installation

Montaje sin ruido, fácil y rápido

* Ceramic, porcelain, glazed surfaces, compact marble, even surfaces with roughness up to 0.5 mm thickness.

* Cerámica, porcelana, materiales vitrificados o mármoles compactos, e incluso superficies con una rugosidad de hasta 0,5 milímetros de espesor.



⊙
HOOK
COLGADOR

S WJC205A0021001

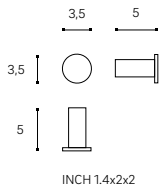

⊙
HOOK
COLGADOR

S WJC235A0021001

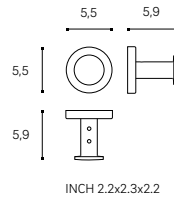

⊙
HOOK
COLGADOR

S WJC205A0121001

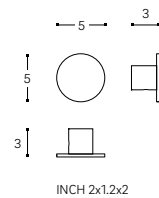

⊙
HOOK (2 U.)
COLGADOR (2 U.)

S **D** WJC205D0021001

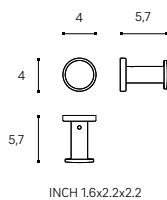

⊙
DOUBLE HOOK
COLGADOR DOBLE

S WJC205A0022001

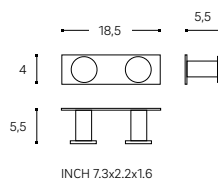

⊙
GLOVE HOOK
PORTAGUANTES

S WJC205A0020001

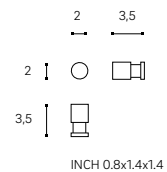



○
RACK SOAP DISH
JABONERA REJILLA

S **WJC205A0039002**

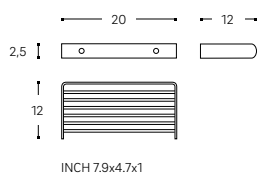

○
CORNER RACK SOAP DISH
JABONERA REJILLA RINCÓN

S **WJC205A0030002**

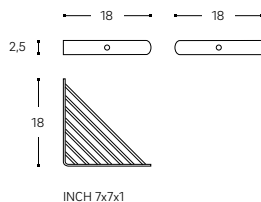

⊙
SOAP WIRE BASKET
JABONERA DE DUCHA

WJC205A0086001

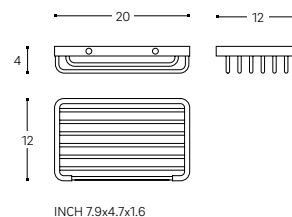

⊙
SOAP WIRE BASKET
JABONERA DE DUCHA

WJC205A0049001

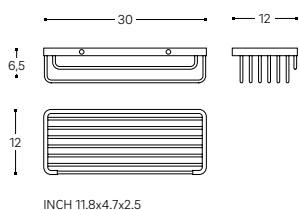

⊙
SOAP WIRE BASKET
JABONERA DE DUCHA

WJC205A0048001
40 CM / INCH 15.7

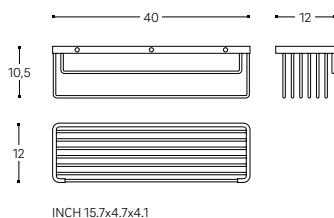

⊙
CORNER SHOWER WIRE BASKET
JABONERA DE DUCHA RINCÓN

WJC205A0050001

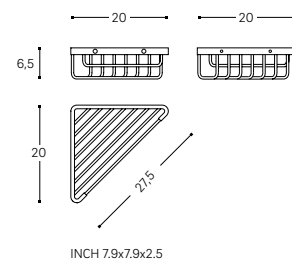



⊙△
SHOWER SOAP DISH *
JABONERA DE DUCHA *

- S** **WJC251A0049051**
CHROME-WHITE / CROMO-BLANCO
- S** **WJC251A0049061**
CHROME-BLACK / CROMO-NEGRO

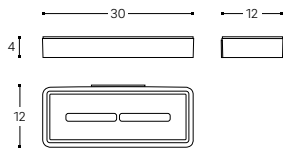

INCH 11.8x4.7x1.6



⊙△
CORNER SOAP DISH *
JABONERA DE DUCHA RINCÓN *

- WJC251A0050051**
CHROME-WHITE / CROMO-BLANCO
- WJC251A0050061**
CHROME-BLACK / CROMO-NEGRO

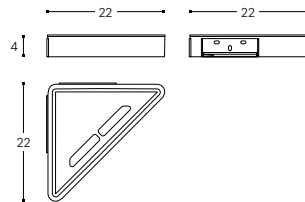

INCH 8.7x8.7x1.6

* CAN BE TAKEN APART FOR CLEANING.
* EXTRAIBLES PARA SU LIMPIEZA.



○△
FREE STANDING BRUSH-HOLDER
PORTACEPILLOS ENCIMERA

WJC205A0051001

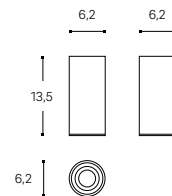

INCH 2.4x2.4x5.3



○△
BRUSH-HOLDER
PORTACEPILLOS

- WJC205A0053001**
- D** **WJC205A0053001D**

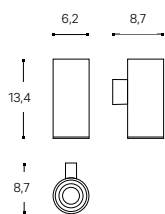

INCH 2.4x3.4x5.3



⊙
FREE STANDING SOAP DISPENSER
DOSIFICADOR ENCIMERA

- S** **WJC205A0004001**
240 ML

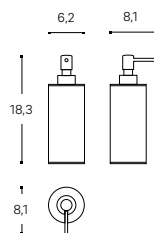

INCH 2.4x3.2x7.2



⊙
SOAP DISPENSER
DOSIFICADOR

- S** **WJC205A0003001**
240 ML
- D** **WJC205A0003001D**
240 ML

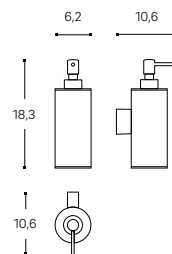

INCH 2.4x4.2x7.2



○
SOAP DISPENSER
DOSIFICADOR

WJC290A0025002
1500 ML

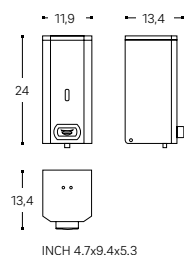

○
TISSUE BOX
CAJA KLEENEX

WJC205A1020001

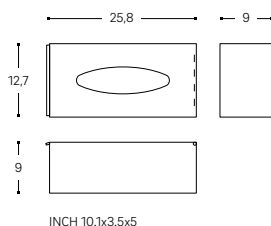

○
TOILET TISSUE DISPENSER
DISPENSADOR PAPEL TOALLA

WJC290A0027002

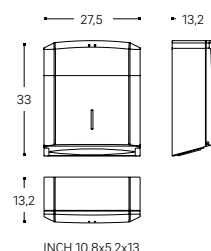

△
HAIRDRYER
SECADOR DE PELO

WJC290A0003000
IP24 1.200 (IPX0)

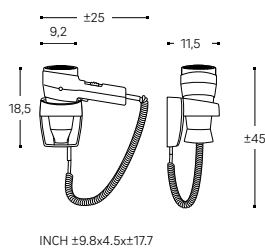

⊙○△◇
WALL MAGNIFYING MIRROR (X5)
ESPEJO DE AUMENTO PARED (X5)

WJC235A0085001
CHROME / CROMO

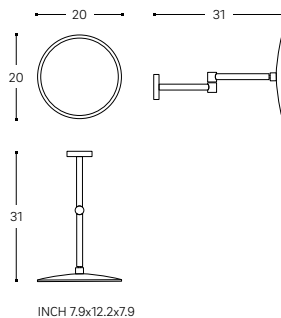

⊙△◇
WALL MAGNIFYING MIRROR (X5)
ESPEJO DE AUMENTO PARED (X5)

S **WJC292A0083001**
CHROME / CROMO

S **WJC292A0083036**
BLACK MATE / NEGRO MATE

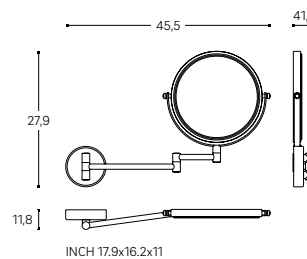



WALL MAGNIFYING MIRROR WITH ADJUSTABLE LED LIGHT*
ESPEJO AUMENTO DE PARED CON LUZ LED REGULABLE*

3W 100-250V

WJC292A0084001
CHROME / CROMO

WJC292A0084036
BLACK MATE / NEGRO MATE

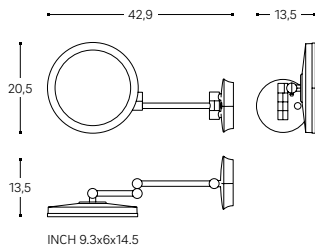

GLASS SHELF
ESTANTE VIDRIO

WJC251A0044001
40 CM / INCH 15.7

WJC251A0045001
60 CM / INCH 23.6

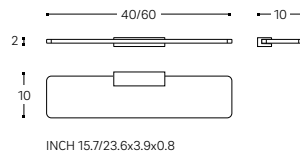

TOWEL RACK
TOALLERO

WJC205A0067001

D WJC205A0067001D

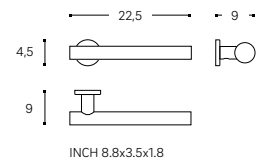

TOWEL RACK
TOALLERO

S WJC205A0064001
41.5 CM / INCH 16.3

D WJC205A0064001D
41.5 CM / INCH 16.3

S WJC205A0065001
59 CM / INCH 23.2

D WJC205A0065001D
59 CM / INCH 23.2

WJC205A0066001
78 CM / INCH 30.7

D WJC205A0066001D
78 CM / INCH 30.7

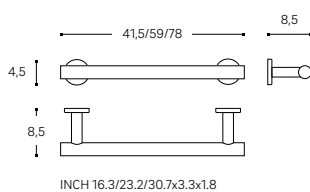

DOUBLE TOWEL RACK
TOALLERO DOBLE

WJC205A0061001

D WJC205A0061001D

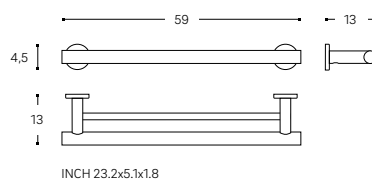

SWIVEL TOWEL RACK
TOALLERO GIRATORIO

WJC205A0074001

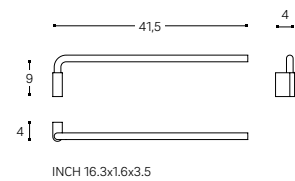



⊙
SWIVEL DOUBLE TOWEL RACK
TOALLERO GIRATORIO DOBLE

WJC240A0075001

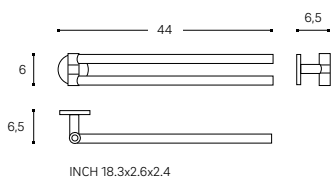

⊙
TOWEL RACK
TOALLERO

S **WJC205A0069001**

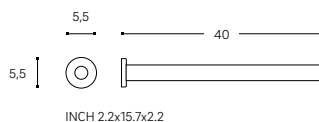

⊙
TOWEL RING
TOALLERO ARO

WJC205A0071001
12 CM / INCH 4.7

D **WJC205A0071001D**
12 CM / INCH 4.7

WJC205A0072001
16 CM / INCH 6.3

D **WJC205A0072001D**
16 CM / INCH 6.3

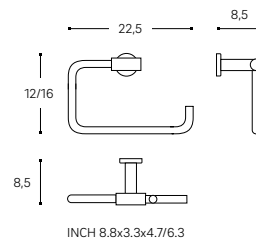

⊙
SHELF TOWEL RACK
TOALLERO ESTANTE

WJC205A0068001

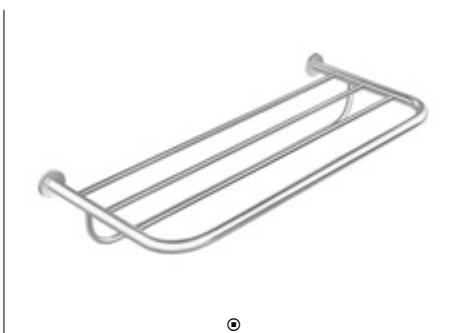
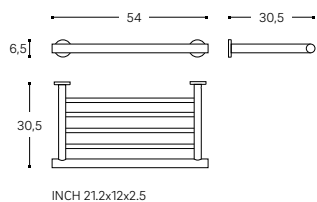

⊙
SHELF TOWEL RACK
TOALLERO ESTANTE

WJC205A1068001
D **WJC205A1068001D**

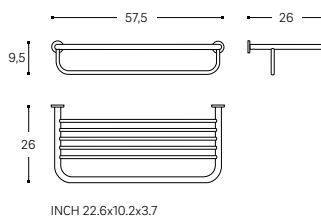

○
GRAB BAR
ASA BAÑERA

S **WJC205A0010001**
30 CM / INCH 11.8

WJC205A0011001
45 CM / INCH 17.7

WJC205A0012001
60 CM / INCH 23.6

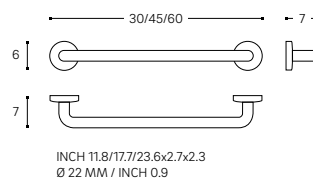



○
 BATH GRAB BAR 135°
 ASA BAÑERA 135°

- WJC205A0013001
RIGHT / DERECHA
- WJC205A0014001
LEFT / IZQUIERDA

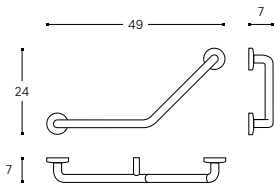

INCH 19.3x2.7x9.4
 Ø 22 MM / INCH 0.9



○
 BATH GRAB BAR 90°
 ASA BAÑERA 90°

- WJC205A0015001
RIGHT / DERECHA
- WJC205A0016001
LEFT / IZQUIERDA

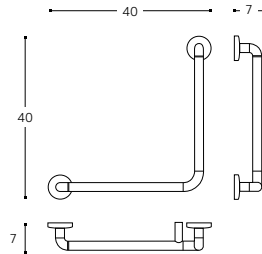

INCH 15.7x2.7x15.7
 Ø 22 MM / INCH 0.9



⊙
 HINGED GRAB BAR
 ASA ABATIBLE

WJC205A0017001

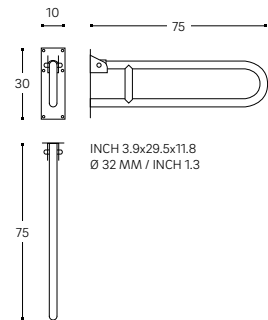

INCH 3.9x29.5x11.8
 Ø 32 MM / INCH 1.3



⊙
 HINGED GRAB BAR WITH PAPER HOLDER
 ASA ABATIBLE CON PORTARROLLOS

WJC205A0018001

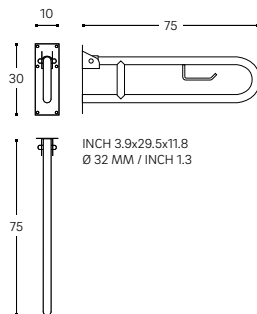

INCH 3.9x29.5x11.8
 Ø 32 MM / INCH 1.3



○
 GRAB BAR/RIGHT SOAP DISH
 ASA BAÑERA/REJILLA DERECHA

WJC205A0026001

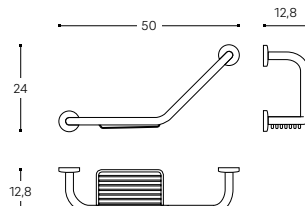

INCH 19.7x5x9.4
 Ø 22 MM / INCH 0.9



⊙△
 PAPER HOLDER WITH COVER
 PORTAPAPEL CON TAPA

S WJC205A0059001

D WJC205A0059001D
 3M ADHESIVE MOUNTING SYSTEM
 SISTEMA FIJACIÓN ADHESIVO 3M

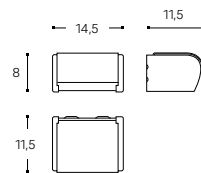

INCH 5.7x4.5x3.1





⊙⊙
PAPER HOLDER WITH COVER
PORTAPAPEL CON TAPA

S WJC235A0059001

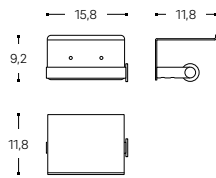

⊙
VERTICAL PAPER HOLDER
PORTAPAPEL VERTICAL

S WJC205A0096001

D WJC205A0096001D

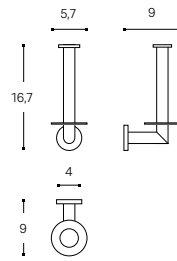

⊙
PAPER HOLDER WITHOUT COVER
PORTAPAPEL SIN TAPA

S WJC205A0058001

S D WJC205A0058001D

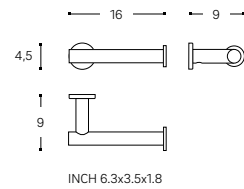

⊙
DOUBLE PAPER HOLDER WITHOUT COVER
PORTAPAPEL DOBLE SIN TAPA

S WJC205A0057001

D WJC205A0057001D

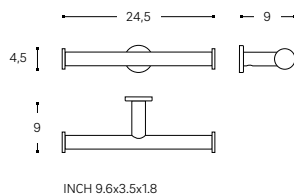

⊙⊙△
FREE STANDING TOILET BRUSH
ESCOBILLERO SUELO

S WJC235A0001001

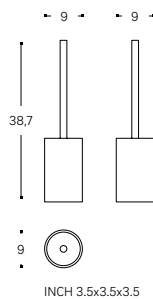

⊙⊙△
TOILET BRUSH
ESCOBILLERO

S WJC235A0000001

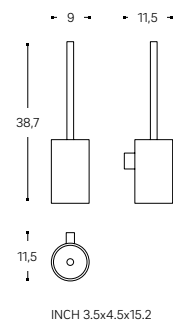



○

FREE STANDING TOILET BRUSH
ESCOBILLERO SUELO

WJC226A0001002

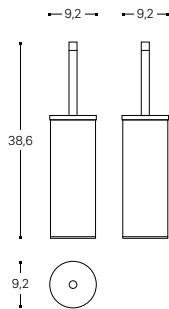

INCH 3.6x3.6x15.2



○

TOILET BRUSH
ESCOBILLERO

WJC226A0097002

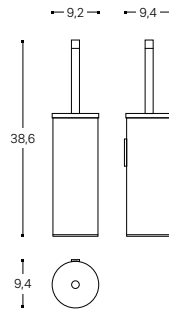

INCH 3.6x3.7x15.2



⊙○△

FREE-STANDING OR WALL MOUNTABLE TOILET BRUSH
ESCOBILLERO SUELO / PARED

S WJC251A0000001

D WJC251D0000001

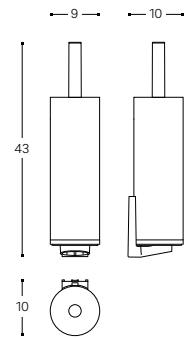

INCH 9.6x3.5x1.8



○

TOILET PAPER DISPENSER
DISPENSADOR PAPEL HIGIÉNICO

S WJC290A0026002

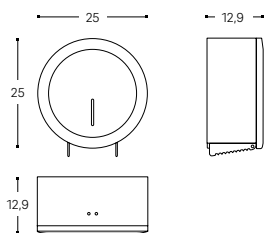

INCH 9.8x9.8x5



△

HYGIENIC PLASTIC BAGS DISPENSER
PORTABOLSITAS HIGIÉNICAS

WJC290A0028001

CHROME / CROMO

WJC290A0028036

BLACK / NEGRO

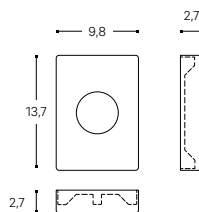

INCH 3.8x1.0x5.4



○△

STOOL
TABURETE

WJC205A0006035

CHROME-MATTE WHITE / CROMO-BLANCO MATE

WJC205A0006036

CHROME-MATTE BLACK / CROMO-NEGRO MATE

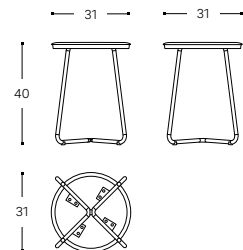

INCH 15.8x15.8x12.2





○
WASTE BIN
PAPELERA

S **WJC205A0702002**
3 L.

S **WJC205A0703002**
5 L.

WJC205A0704002
12 L.

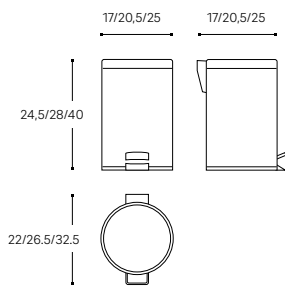

INCH 6.7/8.1/9.8x6.7/8.1/9.8x9.6/11/15.7



○△
5L WASTE BIN
PAPELERA 5L

WJC235A0002001

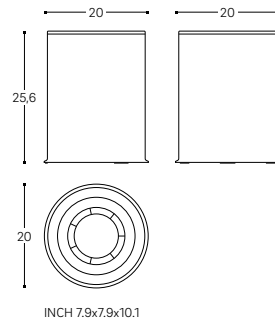

INCH 7.9x7.9x10.1



○△
SHOWER SEAT
ASIENTO DUCHA

WJC205A0034006

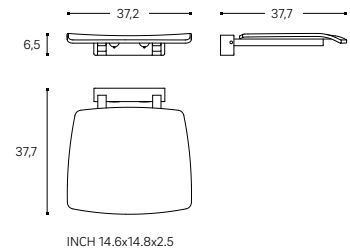

INCH 14.6x14.8x2.5



◎
SOAP WIRE BASKET
JABONERA DE DUCHA

WJC205A0033001

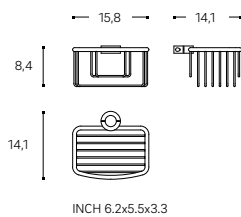

INCH 6.2x5.5x3.3



○
EXTENSIBLE CLOTHE-LINE
TENDEDERO EXTENSIBLE

WJC205A0019001

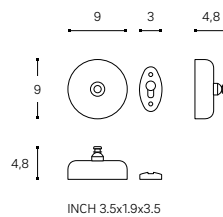

INCH 3.5x1.9x3.5

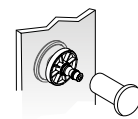

GLASS SHOWER ENCLOSURE HOLDER FOR HOOK
SOPORTE MAMPARA PARA COLGADOR
GLASS 6/8MM / VIDRIO 6/8MM

WJC205A0041001
NOT SUITABLE FOR REFERENCE WJC205A0067001
NO VÁLIDO PARA REF. WJC205A0067001

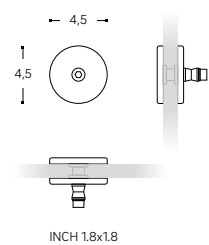

INCH 1.8x1.8

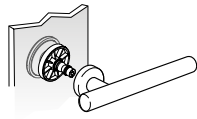

GLASS SHOWER ENCLOSURE HOLDER FOR TOWEL RACK
SOPORTE MAMPARA PARA TOALLERO
GLASS 6/8MM / VIDRIO 6/8MM

WJC205A0040001

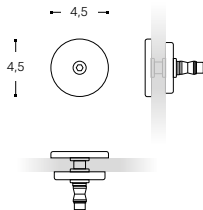

INCH 1.8x1.8

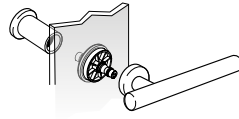

GLASS SHOWER ENCLOSURE HOLDER
FOR TOWEL RACK / HOOK
SOPORTE MAMPARA PARA TOALLERO / COLGADOR
GLASS 6/8MM / VIDRIO 6/8MM

WJC205A0038001

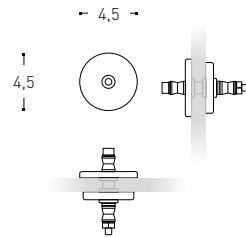

INCH 1.8x1.8

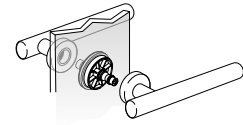

GLASS SHOWER ENCLOSURE HOLDER
FOR TOWEL RACK / TOWEL RACK
SOPORTE MAMPARA PARA TOALLERO / TOALLERO
GLASS 6/8MM / VIDRIO 6/8MM

WJC205A0042001

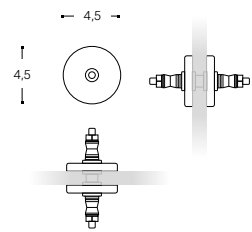

INCH 1.8x1.8



AUTOMATIC DISPENSER
DOSIFICADOR AUTOMÁTICO

WJC290A6509000
MATTE SILVER / PLATA MATE



AUTOMATIC DISPENSER
DOSIFICADOR AUTOMÁTICO

WJC290A6510000
BLACK / NEGRO



FREESTANDING SIMPLE HYGIENE STATION FOR DISPENSER
ESTACIÓN HIGIENE SIMPLE PARA DOSIFICADOR

WJC290A6601000
ANTHRACITE / ANTRACITA





FREESTANDING SIMPLE HYGIENE STATION FOR DISPENSER
ESTACIÓN HIGIENE SIMPLE PARA DOSIFICADOR

WJC290A6603000
OAK / ROBLE



Architect



Design by **Cosmic Studio**

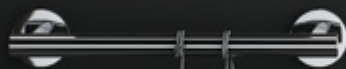



Go to the next level





Cosmic is proud to present **Architect S+**, a complete collection with over 25 different accessories designed to offer maximum functionality. This new proposal stands out for the brand-new, ultra-stable bracket system incorporated into many of the pieces. Architect S+ is safe, superior, sustainable and strong: four values close to Cosmic's heart. Because Cosmic is Innovation's Mind.

Cosmic presenta **Architect S+**, una completa colección con más de 25 accesorios diferentes pensados para ofrecer la máxima funcionalidad. La nueva propuesta destaca por incorporar en muchas de las piezas un sistema de soporte completamente nuevo, de una fijación absoluta. Architect S+ es segura, superior, sostenible y resolutiva, los cuatro valores insignia de Cosmic. Porque Cosmic es Innovation's Mind.





Mobile holder.
A useful addition to your
day-to-day life.

Soporte para teléfono móvil.
Muy útil en tu vida cotidiana.



Shower soap dish with built-in shower squeegee hidden in the base, ready to use. Can be taken apart for cleaning. Anodised aluminium shelf.

Jabonera que incorpora un limpia mamparas, oculto en la base y listo para su uso. Extraíble para una mejor limpieza. Estante de aluminio anodizado.

Wall-mounted brush-holder with translucent tumbler. Secure attachment to the wall. Easy to clean.

Porta cepillos de pared, incluye vaso translúcido. Fijación segura a la pared. Apto para la limpieza.

Soap level indicator. Dispenser button at the bottom. Anti-drip system. Large capacity (400 ml). Easy soap replacement system.

Indicador de nivel de jabón. Accionado por pulsador inferior. Sistema anti goteo. Gran capacidad (400 ml). Fácil reposición del jabón.





400 ml





Double towel rail with fixed bars.
The bars can be opened up,
making it easy to hang towels.
Sturdy bracket.

Doble toallero con barras fijas.
La abertura entre ellas facilita la
colocación de las toallas.
Soporte de gran resistencia.



Fixing disc (wall plate)

The fiberglass mix makes the fixing disc highly resistant. It adapts to the shape of the screw to remain completely fixed.

Disco de fijación (wall plate)

La mezcla con fibra de vidrio hace que el disco de fijación sea muy resistente. Se adapta a la forma del tornillo, quedando completamente fijado.

Triple fixing

Triple fijación

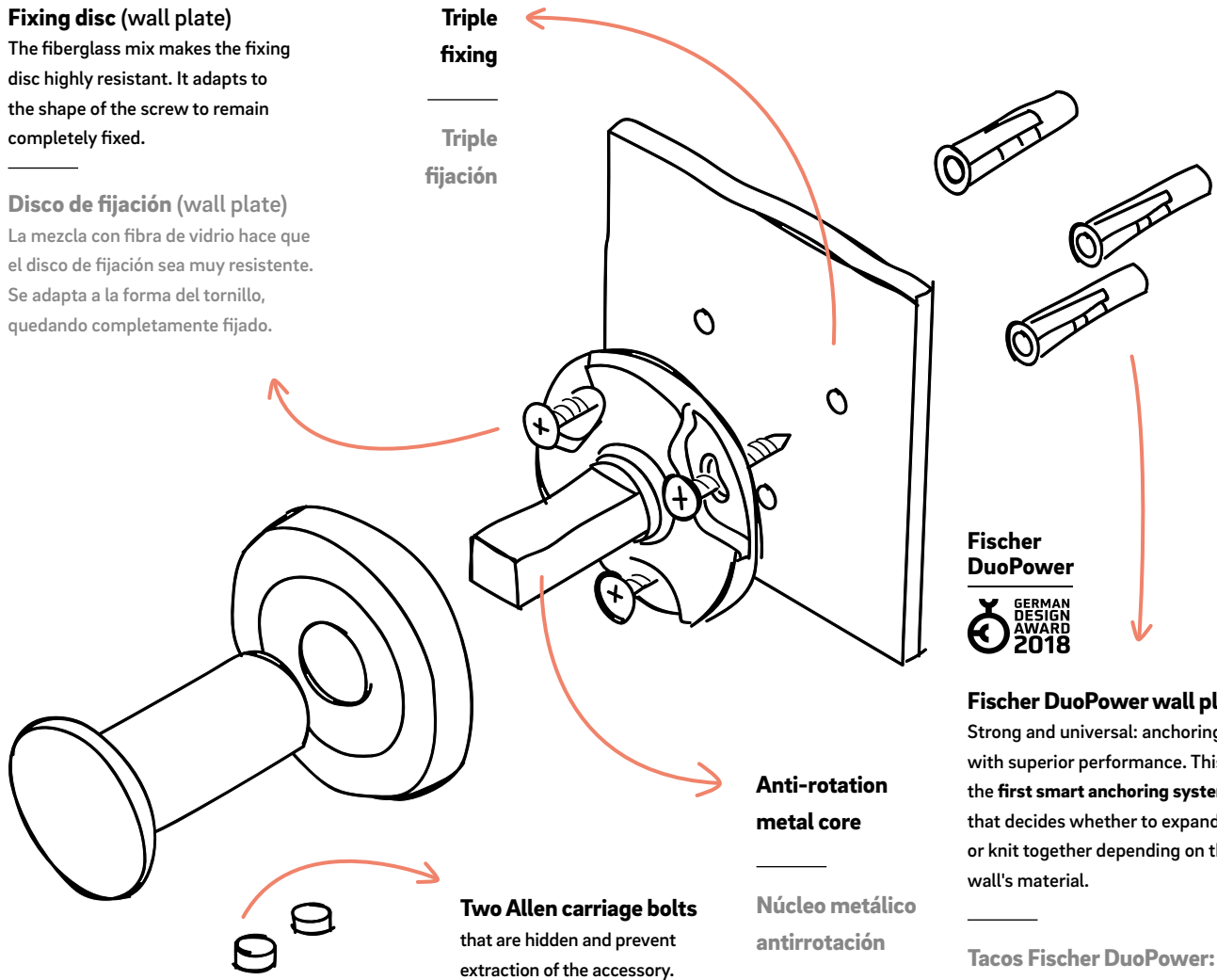

Fischer DuoPower



Fischer DuoPower wall plugs.

Strong and universal: anchoring with superior performance. This is the **first smart anchoring system** that decides whether to expand, fold or knit together depending on the wall's material.

Tacos Fischer DuoPower:

Fuerte y Universal: el anclaje con un rendimiento superior. Es el **primer anclaje inteligente** que decide si se expande, se pliega o se anuda según el material de la pared.

Anti-rotation metal core

Núcleo metálico antirrotación

Two Allen carriage bolts that are hidden and prevent extraction of the accessory.

Dos tornillos ciegos allen que quedan ocultos y privan la extracción del accesorio.

Installation Video
Video de instalación

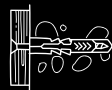

Expanded
Solid walls
Expansión
Paredes macizas

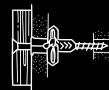

Folded
Wooden walls
Plegado
Paredes de madera



Knitted
Plasterboard walls
Anudado
Paredes de cartón-yeso

Brushed Steel NEW

Cosmic revives the classics with an improved version of the **Brushed Steel** finish for the new Architect S+ accessories collection

Cosmic revive los clásicos con una versión mejorada del acabado **Brushed Steel** para la nueva colección de accesorios Architect S+



Uniform brushing, combinable with the Logic and Suite ranges.

Cepillado uniforme, combinable con las gamas Logic y Suite

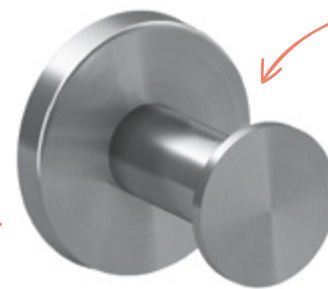

Top trendy among specifiers

Top trendy entre prescriptores

New finish

Nuevo acabado

Brushed Steel Innovation on a classic finish

Inox cepillado Innovación sobre un acabado clásico

Soft Black

Cosmic has developed a new **Soft Black** finish for Architect S+ with an extra matte texture

Cosmic ha desarrollado para Architect S+ un nuevo acabado **Soft Black**, que destaca por ser extra mate

From automotive engineering to your bathroom

Desde la ingeniería automotriz hasta tu baño

Highly scratch resistant

Muy resistente a los rasguños

Strong and long-lasting

Resistente y duradero

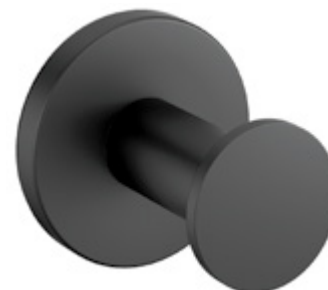

Uniform and compact black coating

Recubrimiento negro compacto y uniforme



⊙
HOOK
COLGADOR

- S** **WJC235A0021001**
CHROME / CROMO
- S** **WJC235A0021003**
BRUSHED STEEL / INOX CEPILLADO
- S** **WJC235A0021036**
SOFT BLACK

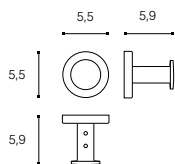

INCH 2.2x2.3x2.2



○
HOOK (X2)
PERCHA (X2)
GLASS 6/8MM / VIDRIO 6/8MM

- WJC235A0023001**
CHROME / CROMO
- WJC235A0023003**
BRUSHED STEEL / INOX CEPILLADO
- WJC235A0023036**
SOFT BLACK

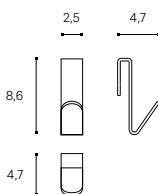

INCH 1x1.9x3.4



⊙△
BRUSH-HOLDER
PORTACEPILLOS

- WJC235A0053001**
CHROME / CROMO
- WJC235A0053003**
BRUSHED STEEL / INOX CEPILLADO
- WJC235A0053036**
SOFT BLACK

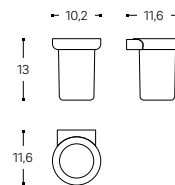

INCH 4x4.6x5.1



⊙△
SOAP DISPENSER
DOSIFICADOR

- WJC235A0003001**
400ML CHROME / CROMO
- WJC235A0003003**
400ML BRUSHED STEEL / INOX CEPILLADO
- WJC235A0003036**
400ML SOFT BLACK

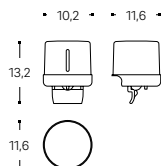

INCH 4x4.6x5.2



⊙○△◇
WALL MAGNIFYING MIRROR (X5)
ESPEJO DE AUMENTO PARED (X5)

- S** **WJC235A0085001**
CHROME / CROMO
- S** **WJC235A0085003**
BRUSHED STEEL / INOX CEPILLADO
- S** **WJC235A0085036**
SOFT BLACK

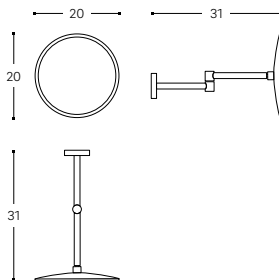

INCH 7.9x12.2x7.9



○
TISSUE BOX
CAJA KLEENEX

- WJC235A0028002**
CHROME / CROMO
- S** **WJC235A0028003**
BRUSHED STEEL / INOX CEPILLADO
- S** **WJC235A0028036**
SOFT BLACK

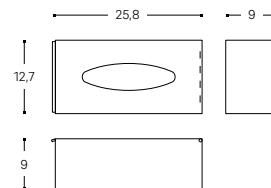

INCH 10.1x3.5x5



●●
SHELF
ESTANTE

- WJC235A0044001**
CHROME / CROMO
- WJC235A0044003**
BRUSHED STEEL / INOX CEPILLADO
- WJC235A0044036**
SOFT BLACK

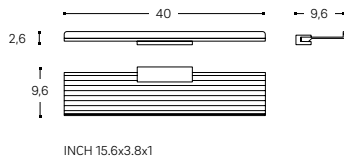

△
TRAY
BANDEJA

- WJC235A0033034**
SMOKED / FUME

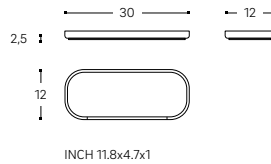

●●●
SHOWER SOAP DISH
JABONERA DE DUCHA

- WJC235A0049001**
CHROME / CROMO
- WJC235A0049003**
BRUSHED STEEL / INOX CEPILLADO
- WJC235A0049036**
SOFT BLACK

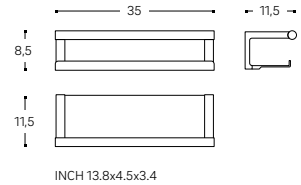

●●●△
SHOWER SOAP DISH WITH GLASS WIPER
JABONERA DUCHA CON LIMPIACRISTALES

- WJC235A0048001**
CHROME / CROMO
- WJC235A0048003**
BRUSHED STEEL / INOX CEPILLADO
- WJC235A0048036**
SOFT BLACK

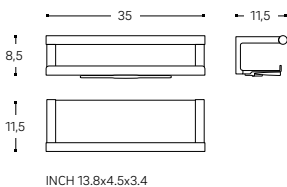

●●●△
DOUBLE HANGING SHOWER SOAP DISH
DOBLE JABONERA DE DUCHA COLGANTE
GLASS 6/8MM / VIDRIO 6/8MM

- WJC235A0047001**
CHROME / CROMO
- WJC235A0047036**
SOFT BLACK

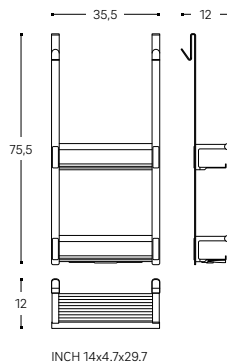

●●
TOWEL RACK
TOALLERO

- WJC235A0063001**
30 CM / INCH 11.8 CHROME / CROMO
- WJC235A0064001**
45 CM / INCH 17.7 CHROME / CROMO
- WJC235A0065001**
60 CM / INCH 23.6 CHROME / CROMO
- WJC235A0063003**
30 CM / INCH 11.8 BRUSHED STEEL / INOX CEPILLADO
- WJC235A0064003**
45 CM / INCH 17.7 BRUSHED STEEL / INOX CEPILLADO
- WJC235A0065003**
60 CM / INCH 23.6 BRUSHED STEEL / INOX CEPILLADO
- WJC235A0063036**
30 CM / INCH 11.8 SOFT BLACK
- WJC235A0064036**
45 CM / INCH 17.7 SOFT BLACK
- WJC235A0065036**
60 CM / INCH 23.6 SOFT BLACK

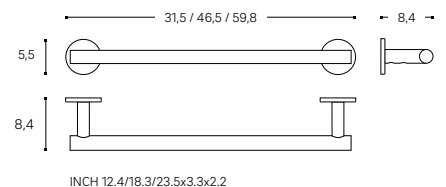



DOUBLE TOWEL RACK
TOALLERO DOBLE

WJC235A0061001
45 CM / INCH 17.7 CHROME / CROMO

WJC235A0060001
60 CM / INCH 23.6 CHROME / CROMO

WJC235A0061003
45 CM / INCH 17.7 BRUSHED STEEL / INOX CEPILLADO

WJC235A0060003
60 CM / INCH 23.6 BRUSHED STEEL / INOX CEPILLADO

WJC235A0061036
45 CM / INCH 17.7 SOFT BLACK

WJC235A0060036
60 CM / INCH 23.6 SOFT BLACK

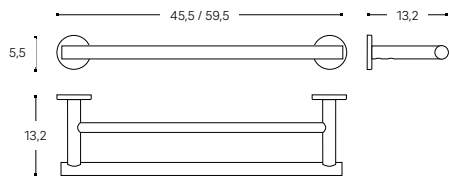

INCH 17.9/23.2x5.2x2.2



SWIVEL DOUBLE TOWEL RACK
TOALLERO GIRATORIO DOBLE

WJC235A0075001
CHROME / CROMO

WJC235A0075003
BRUSHED STEEL / INOX CEPILLADO

WJC235A0075036
SOFT BLACK

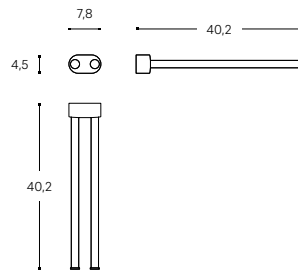

INCH 3x15.8x1.8



TOWEL RACK
TOALLERO

WJC235A0069001
CHROME / CROMO

WJC235A0069003
BRUSHED STEEL / INOX CEPILLADO

WJC235A0069036
SOFT BLACK

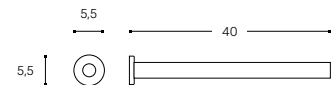

INCH 2.2x15.7x2.2



TOWEL RING
TOALLERO ARO

WJC235A0071001
CHROME / CROMO

WJC235A0071003
BRUSHED STEEL / INOX CEPILLADO

WJC235A0071036
SOFT BLACK

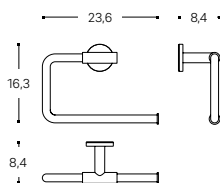

INCH 9.3x3.3x6.4



TOWEL RACK SHELF
TOALLERO ESTANTE

WJC235A0068001
CHROME / CROMO

WJC235A0068003
BRUSHED STEEL / INOX CEPILLADO

WJC235A0068036
SOFT BLACK

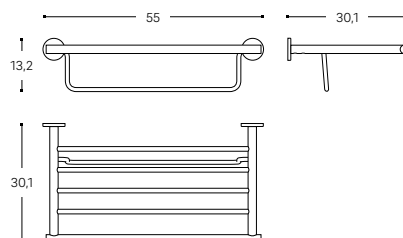

INCH 21.6x11.8x5.2



GRAB BAR
ASA BAÑERA

WJC235A0024001
30 CM / INCH 11.8 CHROME / CROMO

WJC235A0025001
45 CM / INCH 17.7 CHROME / CROMO

WJC235A0024003
30 CM / INCH 11.8 BRUSHED STEEL / INOX CEPILLADO

WJC235A0025003
45 CM / INCH 17.7 BRUSHED STEEL / INOX CEPILLADO

WJC235A0024036
30 CM / INCH 11.8 SOFT BLACK

WJC235A0025036
45 CM / INCH 17.7 SOFT BLACK

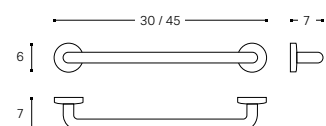

INCH 11.8/17.7x2.7x2.3
Ø 22 MM / INCH 0.9



PAPER HOLDER WITH COVER
PORTAPAPEL CON TAPA

- S** **WJC235A0059001**
CHROME / CROMO
- S** **WJC235A0059003**
BRUSHED STEEL / INOX CEPILLADO
- S** **WJC235A0059036**
SOFT BLACK

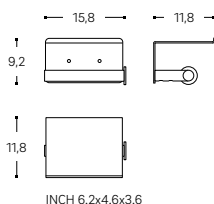

PAPER HOLDER WITHOUT COVER
PORTAPAPEL SIN TAPA

- S** **WJC235A0062001**
CHROME / CROMO
- S** **WJC235A0062003**
BRUSHED STEEL / INOX CEPILLADO
- S** **WJC235A0062036**
SOFT BLACK

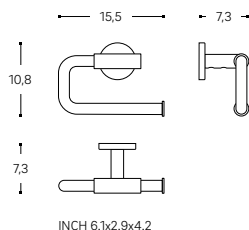

PAPER HOLDER WITHOUT COVER
PORTAPAPEL SIN TAPA

- S** **WJC235A0058001**
CHROME / CROMO
- S** **WJC235A0058003**
BRUSHED STEEL / INOX CEPILLADO
- S** **WJC235A0058036**
SOFT BLACK

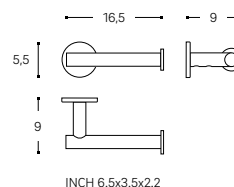

DOUBLE PAPER HOLDER WITHOUT COVER
PORTAPAPEL DOBLE SIN TAPA

- S** **WJC235A0057001**
CHROME / CROMO
- S** **WJC235A0057003**
BRUSHED STEEL / INOX CEPILLADO
- S** **WJC235A0057036**
SOFT BLACK

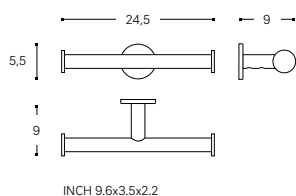

VERTICAL PAPER HOLDER
PORTAPAPEL VERTICAL

- S** **WJC235A0096001**
CHROME / CROMO
- S** **WJC235A0096003**
BRUSHED STEEL / INOX CEPILLADO
- S** **WJC235A0096036**
SOFT BLACK

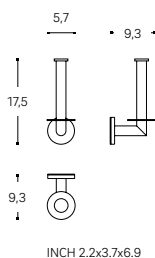

FREE STANDING TOILET BRUSH
ESCOBILLERO SUELO

- S** **WJC235A0001001**
CHROME / CROMO
- S** **WJC235A0001003**
BRUSHED STEEL / INOX CEPILLADO
- S** **WJC235A0001036**
SOFT BLACK

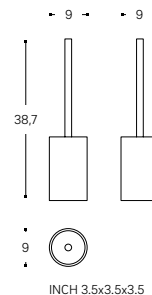



⊙ ○ △
TOILET BRUSH
ESCOBILLERO

- WJC235A0000001**
CHROME / CROMO
- WJC235A0000003**
BRUSHED STEEL / INOX CEPILLADO
- WJC235A0000036**
SOFT BLACK

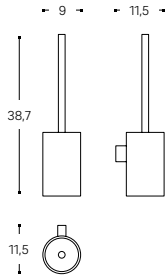

INCH 3.5x4.5x15.2



○ △
5L WASTE BIN
PAPELERA 5L

- WJC235A0002001**
CHROME / CROMO
- WJC235A0002003**
BRUSHED STEEL / INOX CEPILLADO
- WJC277A0002036**
SOFT BLACK

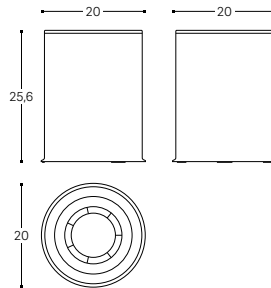

INCH 7.9x7.9x10.1

S ALTA DISPONIBILIDAD.
HIGH AVAILABILITY.

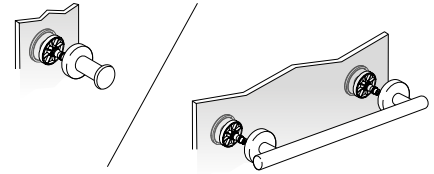

GLASS SHOWER ENCLOSURE HOLDER FOR HOOK
SOPORTE MAMPARA PARA COLGADOR
GLASS 6/8MM / VIDRIO 6/8MM
WJC235A0040001
CHROME / CROMO
WJC235A0040003
BRUSHED STEEL / INOX CEPILLADO
WJC235A0040036
SOFT BLACK

GLASS SHOWER ENCLOSURE HOLDER FOR TOWEL RACK (2U. REQUIRED)
SOPORTE MAMPARA PARA TOALLERO (REQUIERE 2 U.)
GLASS 6/8MM / VIDRIO 6/8MM

- WJC235A0040001**
CHROME / CROMO
- WJC235A0040001**
CHROME / CROMO
- WJC235A0040003**
BRUSHED STEEL / INOX CEPILLADO
- WJC235A0040003**
BRUSHED STEEL / INOX CEPILLADO
- WJC235A0040036**
SOFT BLACK
- WJC235A0040036**
SOFT BLACK

GLASS SHOWER ENCLOSURE HOLDER FOR TOWEL RACK (2U. REQUIRED)
SOPORTE MAMPARA PARA TOALLERO (REQUIERE 2 U.)
GLASS 6/8MM / VIDRIO 6/8MM

- WJC235A0040001**
CHROME / CROMO
- WJC235A0040001**
CHROME / CROMO
- WJC235A0040003**
BRUSHED STEEL / INOX CEPILLADO
- WJC235A0040003**
BRUSHED STEEL / INOX CEPILLADO
- WJC235A0040036**
SOFT BLACK
- WJC235A0040036**
SOFT BLACK

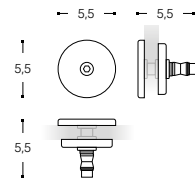

INCH 2.2x2.2x2.2

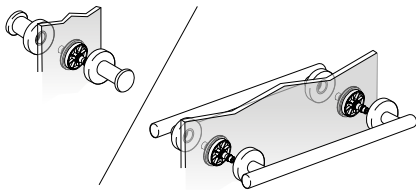

GLASS SHOWER ENCLOSURE HOLDER FOR HOOK / HOOK
SOPORTE MAMPARA PARA COLGADOR / COLGADOR
GLASS 6/8MM / VIDRIO 6/8MM
WJC235A0042000

GLASS SHOWER ENCLOSURE HOLDER FOR TOWEL RACK / TOWEL RACK (2U. REQUIRED)
SOPORTE MAMPARA PARA TOALLERO / TOALLERO (REQUIERE 2 U.)
GLASS 6/8MM / VIDRIO 6/8MM

- WJC235A0042000**
- WJC235A0042000**
- WJC235A0042000**

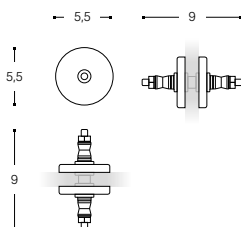

INCH 2.2x3.5x2.2

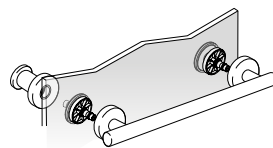

GLASS SHOWER ENCLOSURE HOLDER FOR TOWEL RACK / HOOK
SOPORTE MAMPARA PARA TOALLERO / COLGADOR
GLASS 6/8MM / VIDRIO 6/8MM

- WJC235A0042000**
- WJC235A0040001**
CHROME / CROMO
- WJC235A0042000**
- WJC235A0040003**
BRUSHED STEEL / INOX CEPILLADO
- WJC235A0042000**
- WJC235A0040036**
SOFT BLACK

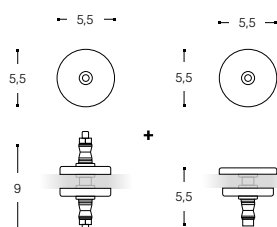

INCH 2.2x3.2x2.2

INCH 2.2x2.2x2.2

B-Smart

Design by **Cosmic Studio**







Our containers are designed with the idea of providing each member of the family with their own space for storage.

Contenedores pensados para que cada miembro de la familia tenga su propio espacio de almacenaje.







10
YEARS GUARANTEE
AÑOS GARANTÍA
COSMIC

B-Smart has successfully passed the high demanding tests of long last durability and resistance to extreme uses (static charge or impact testing) to assure long last durability of the product.

Toda la gama **B-Smart** ha superado con éxito exigentes tests de durabilidad y resistencia a usos extremos (cargas estáticas o test de impacto), para asegurar una larga vida al producto.



FINISHES / ACABADOS



White
Blanco

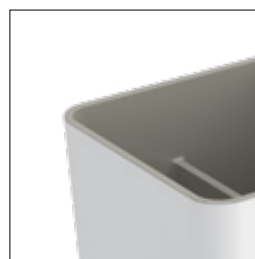

White - Grey
Blanco - Gris



○
HOOK (2 U.)
COLGADOR (2 U.)

WJB005A0102002
STAINLESS STEEL / INOX

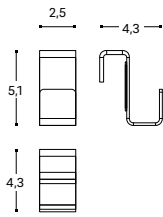

INCH 1x1.7x2



△
BRUSH-HOLDER
PORTACEPILLOS

WJB007A0035005
WHITE / BLANCO
WJB007A0035059
WHITE - GREY / BLANCO - GRIS

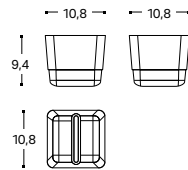

INCH 4.3x4.3x3.7



△
SOAP DISPENSER
DOSIFICADOR

WJB007A0004005
425 ML WHITE / BLANCO
WJB007A0004059
425 ML WHITE - GREY / BLANCO - GRIS

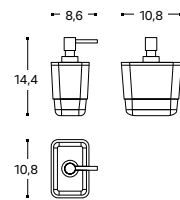

INCH 4.3x3.4x5.7



△
CONTAINER WITH COVER
CONTAINER CON TAPA

WJB007A0048005
WHITE / BLANCO
WJB007A0048059
WHITE - GREY / BLANCO - GRIS

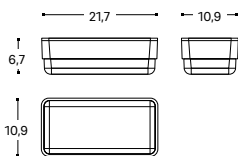

INCH 8.5x4.3x2.6



△
DOUBLE CONTAINER WITH COVER
CONTAINER DOBLE CON TAPA

WJB007A0049005
WHITE / BLANCO
WJB007A0049059
WHITE - GREY / BLANCO - GRIS

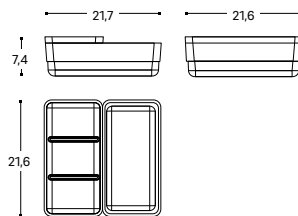

INCH 8.5x8.6x2.9



△
TOILET BRUSH
ESCOBILLERO

WJB007A0001005
WHITE / BLANCO
WJB007A0001059
WHITE - GREY / BLANCO - GRIS

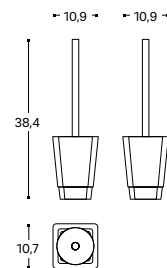

INCH 4.3x4.3x15.1





TOWEL RACK
TOALLERO

BONDED WITH HIGH ADHESION ADHESIVE (3M)
FIJACIÓN CON ADHESIVO DE ALTA ADHERENCIA (3M)

WJB007A0063005
WHITE / BLANCO

WJB007A0063059
WHITE - GREY / BLANCO - GRIS

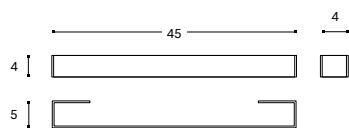

INCH 17.7x2x1.6



Bath Life

Design by **Carles Ferruz**









Set of perfectly straight lines and angles within an exclusive and timeless design.

Conjugación de líneas y ángulos rectos perfectos, de diseño exclusivo y atemporal.







Bath Life

Design by **Carles Ferruz**



Bath Life has successfully passed the high demanding tests of long last durability and resistance to extreme uses (static charge or impact testing) to assure long last durability of the product.

Toda la gama **Bath Life** ha superado con éxito exigentes tests de durabilidad y resistencia a usos extremos (cargas estáticas o test de impacto), para asegurar una larga vida al producto.



FEATURES / CARACTERÍSTICAS

Easy installation: double pitch screw.
Hidden attachments. Anti-corrosion.

Fácil instalación: tornillo de doble paso.
Fijaciones ocultas. Anticorrosión.

FINISHES / ACABADOS

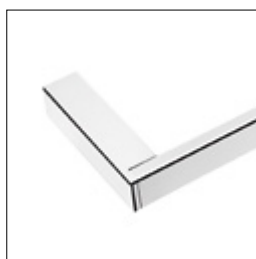

001
Chrome
Cromo

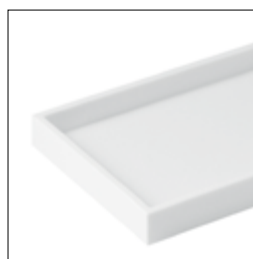

005
White
Blanco



Accessories | Accesorios



⊙
HOOK
COLGADOR

Ⓢ WJC229A0021001

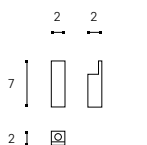

INCH 0.8x0.8x2.7



⊙△
FREE STANDING BRUSH-HOLDER
PORTACEPILLOS ENCIMERA

WJC229A0051001

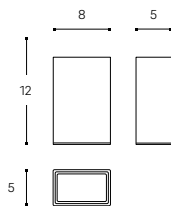

INCH 3.1x2.8x4.7



⊙△
BRUSH-HOLDER
PORTACEPILLOS

WJC229A0052001

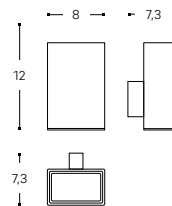

INCH 3.1x1.9x4.7



⊙
FREE STANDING SOAP DISPENSER
DOSIFICADOR ENCIMERA

WJC229A0004001
275 ML

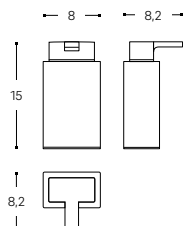

INCH 3.1x3.2x5.9



⊙
SOAP DISPENSER
DOSIFICADOR

WJC229A0005001
275 ML

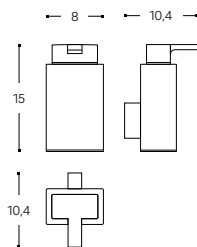

INCH 3.1x4x5.9



⊙
TOWEL RACK
TOALLERO

Ⓢ WJC229A0063001
30 CM / INCH 11.8

Ⓢ WJC229A0069001
45 CM / INCH 17.7

Ⓢ WJC229A0064001
60 CM / INCH 23.6

WJC229A0065001
90 CM / INCH 35.4

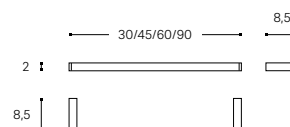

INCH 11.8/17.7/23.6/35.4x3.3x0.8





⊙
SWIVEL TOWEL RACK
TOALLERO GIRATORIO

WJC229A0074001

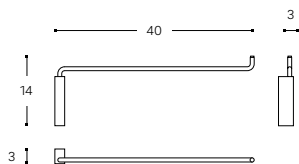

INCH 15.7x1.2x0.8



⊙
TOWEL RING
TOALLERO ARO

WJC229A0071001

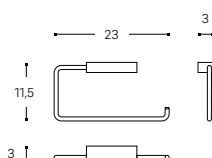

INCH 9x1.2x4.5



⊙
TOWEL RACK SHELF
TOALLERO ESTANTE

WJC229A0068001

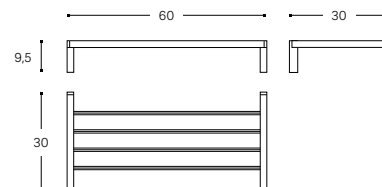

INCH 23.6x11.8x3.7



⊙
FREE STANDING TOWEL RACK
TOALLERO DE PIE

WJC229A0066001

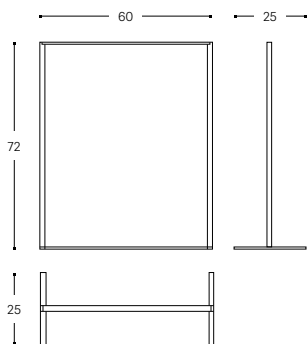

INCH 23.6x9.8x28.3



△
DISH
BANDEJA

WJC229A0033005

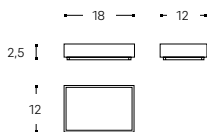

INCH 7.1x4.7x1



△
CONTAINER
PORTA-OBJETOS

WJC229A0053005

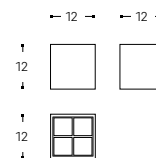

INCH 4.7x4.7x4.7





● ●
SHELF RACK WITH SHELF
BARRA ESTANTE CON ESTANTE

WJC229A0081001
30 CM / INCH 11.8
WJC229A0091001
60 CM / INCH 23.6

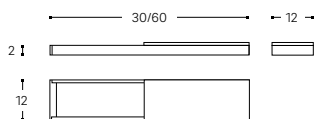

INCH 11.8/23.6x4.7x0.8



● ●
SHELF RACK WITH TRAY AND CONTAINER
BARRA ESTANTE CON BANDEJA Y PORTAOBJETOS

WJC229A0082001
30 CM / INCH 11.8
WJC229A0092001
60 CM / INCH 23.6

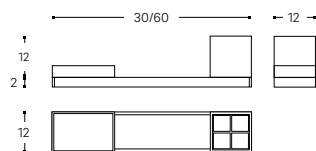

INCH 11.8/23.6x4.7x0.8



●
SHELF RACK
BARRA ESTANTE

WJC229A0040001
30 CM / INCH 11.8
WJC229A0060001
60 CM / INCH 23.6

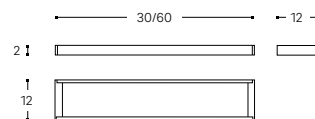

INCH 11.8/23.6x4.7x0.8



●
SHELF *
ESTANTE *

WJC229A0045005
30 CM / INCH 11.8

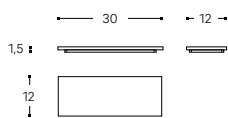

INCH 11.8x4.7x0.8



●
PAPER HOLDER WITH COVER
PORTAPAPEL CON TAPA

● **WJC229A0056001**

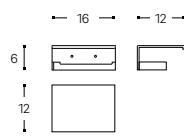

INCH 6.3x4.7x2.4



●
PAPER HOLDER WITH COVER
PORTAPAPEL CON TAPA

WJC229A0059001

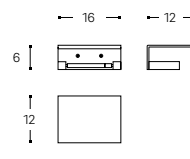

INCH 6.3x4.7x2.4

Bath Life

Design by **Carles Ferruz**

ALTA DISPONIBILIDAD.
HIGH AVAILABILITY.



PAPER HOLDER WITHOUT COVER
PORTAPAPEL SIN TAPA

WJC229A0062001

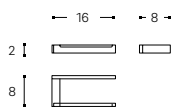

INCH 6.3x4.7x0.8



PAPER HOLDER WITHOUT COVER
PORTAPAPEL SIN TAPA

WJC229A0058001

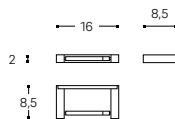

INCH 6.3x3.3x0.8



FREE-STANDING OR WALL TOILET BRUSH
ESCOBILLERO SUELO/PARED

WJC229A0000001

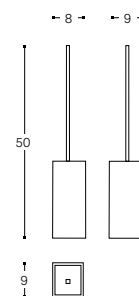

INCH 3.1x3.5x19.7





Belle

Design by Cosmic Studio







The soft lines and evolved shapes of these accessories are characteristic of products that express long-lasting, harmonious elegance.

Líneas suaves y formas evolucionadas propias de esos productos que expresan una elegancia armoniosa y duradera.













10
YEARS GUARANTEE
AÑOS GARANTÍA
—
COSMIC

3
YEARS GUARANTEE
AÑOS GARANTÍA
—
GOLD



Belle has successfully passed the high demanding tests of long last durability and resistance to extreme uses (static charge or impact testing) to assure long last durability of the product.

Toda la gama Belle ha superado con éxito exigentes tests de durabilidad y resistencia a usos extremos (cargas estáticas o test de impacto), para asegurar una larga vida al producto.

FEATURES / CARACTERÍSTICAS

Easy installation: double pitch screw.
Hidden attachments. Anti-corrosion.

Fácil instalación: tornillo de doble paso.
Fijaciones ocultas. Anticorrosión.

FINISHES / ACABADOS



004
Gold
Oro



001
Chrome
Cromo



008
White-Gold
Blanco-Oro



009
White-Chrome
Blanco-Cromo



HOOK
COLGADOR

- WJP076A3001004**
GOLD / ORO
- WJP076A3001001**
CHROME / CROMO
- WJP076A3001008**
WHITE-GOLD / BLANCO-ORO
- WJP076A3001009**
WHITE-CHROME / BLANCO-CROMO

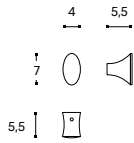

INCH 1.6x2.2x2.8



TOWEL RACK
TOALLERO

- WJP076A1060004**
GOLD / ORO
- WJP076A1060001**
CHROME / CROMO
- WJP076A1060008**
WHITE-GOLD / BLANCO-ORO
- WJP076A1060009**
WHITE-CHROME / BLANCO-CROMO

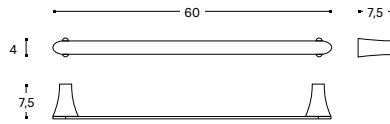

INCH 23.6x3.5x1.6



TOWEL RACK
TOALLERO

- WJP076A1040004**
GOLD / ORO
- WJP076A1040001**
CHROME / CROMO
- WJP076A1040008**
WHITE-GOLD / BLANCO-ORO
- WJP076A1040009**
WHITE-CHROME / BLANCO-CROMO

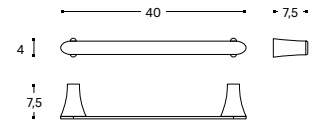

INCH 15.7x3.5x1.6



TOWEL RING
TOALLERO ARO

- WJP076A2005004**
GOLD / ORO
- WJP076A2005001**
CHROME / CROMO
- WJP076A2005008**
WHITE-GOLD / BLANCO-ORO
- WJP076A2005009**
WHITE-CHROME / BLANCO-CROMO

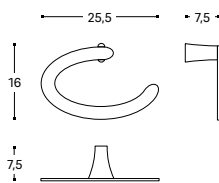

INCH 10x3x6.3



RIGHT PAPER HOLDER WITHOUT COVER
PORTAPAPEL SIN TAPA DERECHO

- WJP076A4001004**
GOLD / ORO
- WJP076A4001001**
CHROME / CROMO
- WJP076A4001008**
WHITE-GOLD / BLANCO-ORO
- WJP076A4001009**
WHITE-CHROME / BLANCO-CROMO

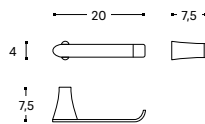

INCH 7.9x3x1.6



LEFT PAPER HOLDER WITHOUT COVER
PORTAPAPEL SIN TAPA IZQUIERDO

- WJP076A4010004**
GOLD / ORO
- WJP076A4010001**
CHROME / CROMO
- WJP076A4010008**
WHITE-GOLD / BLANCO-ORO
- WJP076A4010009**
WHITE-CHROME / BLANCO-CROMO

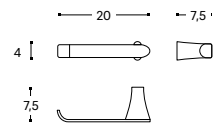

INCH 7.9x3x1.6





RIGHT PAPER HOLDER WITH COVER
PORTAPAPEL CON TAPA DERECHO

- WJP076A4002004**
GOLD / ORO
- WJP076A4002001**
CHROME / CROMO
- WJP076A4002008**
WHITE-GOLD / BLANCO-ORO
- WJP076A4002009**
WHITE-CHROME / BLANCO-CROMO

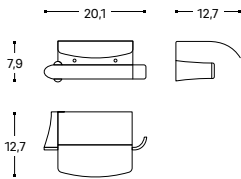

INCH 7.9x5x3.1



PAPER HOLDER WITH COVER
PORTAPAPEL CON TAPA

- WJP076A4020004**
GOLD / ORO
- WJP076A4020001**
CHROME / CROMO
- WJP076A4020008**
WHITE-GOLD / BLANCO-ORO
- WJP076A4020009**
WHITE-CHROME / BLANCO-CROMO

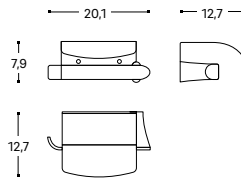

INCH 7.9x5x3.1



TOILET BRUSH
ESCOBILLERO

- WJP076A9001001**
WHITE-GOLD / BLANCO-ORO
- WJP076A9001004**
WHITE-CHROME / BLANCO-CROMO

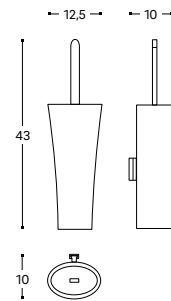

INCH 4.9x3.9x16.9



FREE STANDING TOILET BRUSH
ESCOBILLERO SUELO

- WJP076A9050001**
WHITE-GOLD / BLANCO-ORO
- WJP076A9050004**
WHITE-CHROME / BLANCO-CROMO

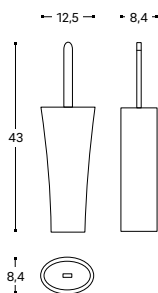

INCH 4.9x3.3x16.9



BRUSH-HOLDER
PORTACEPILLOS

- WJP076A7001001**
WHITE-GOLD / BLANCO-ORO
- WJP076A7001004**
WHITE-CHROME / BLANCO-CROMO

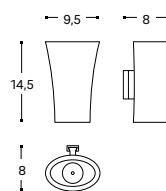

INCH 3.7x3.1x5.7



SOAP DISPENSER
DOSIFICADOR

- WJP076A7801001**
125 ML WHITE-GOLD / BLANCO-ORO
- WJP076A7801004**
125 ML WHITE-CHROME / BLANCO-CROMO

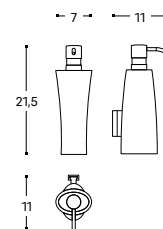

INCH 2.8x4.3x8.5





SOAP DISH
JABONERA

WJP076A6001001
WHITE-GOLD / BLANCO-ORO
WJP076A6001004
WHITE-CHROME / BLANCO-CROMO

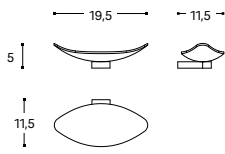

INCH 7.7x2



SHOWER SOAP DISH
JABONERA DE DUCHA

WJP076A6020001
WHITE-GOLD / BLANCO-ORO
WJP076A6020004
WHITE-CHROME / BLANCO-CROMO

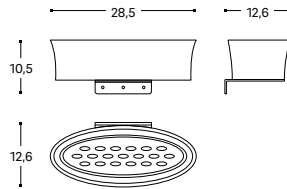

INCH 11.2x5x4.1



FREE STANDING BRUSH-HOLDER
PORTACEPILLOS ENCIMERA

WJP076A7050001
WHITE-GOLD / BLANCO-ORO
WJP076A7050004
WHITE-CHROME / BLANCO-CROMO

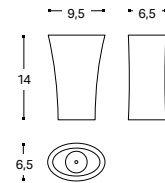

INCH 3.7x2.6x5.7



FREE STANDING SOAP DISPENSER
DOSIFICADOR ENCIMERA

WJP076A7831001
125 ML WHITE-GOLD / BLANCO-ORO
WJP076A7831004
125 ML WHITE-CHROME / BLANCO-CROMO

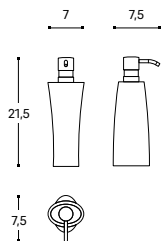

INCH 2.8x3x8.5



FREE STANDING SOAP DISH
JABONERA ENCIMERA

WJP076A6050001
WHITE-GOLD / BLANCO-ORO
WJP076A6050004
WHITE-CHROME / BLANCO-CROMO

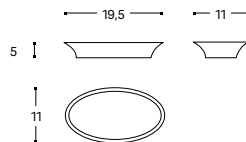

INCH 7.7x4.3x2



POT
FRASCO

WJP076A7503001
WHITE-GOLD / BLANCO-ORO
WJP076A7503004
WHITE-CHROME / BLANCO-CROMO

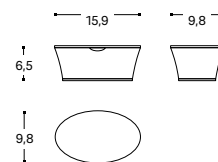

INCH 6.3x3.9x2.6





TISSUE BOX
CAJA KLEENEX

WJP076A9401001
WHITE-GOLD / BLANCO-ORO
WJP076A9401004
WHITE-CHROME / BLANCO-CROMO

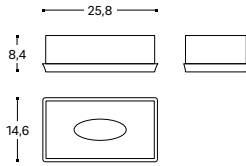

INCH 10.2x5.7x3.3



WASTE BIN
PAPELERA

WJP076A9350001
WHITE-GOLD / BLANCO-ORO
WJP076A9350004
WHITE-CHROME / BLANCO-CROMO

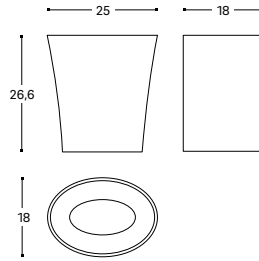

INCH 9.8x7.1x10.5



FREE STANDING MAGNIFYING MIRROR
ESPEJO AUMENTO ENCIMERA

WJP076A8101001
X3/X5 WHITE-GOLD / BLANCO-ORO
WJP076A8101004
X3/X5 WHITE-CHROME / BLANCO-CROMO

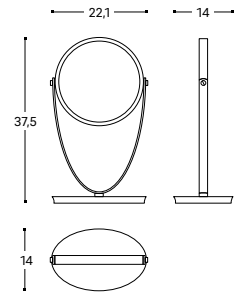

INCH 8.7x5.5x14.8



ROUND TISSUE BOX
CAJA KLEENEX REDONDA

WJP059A7505004
GOLD / ORO
WJP059A7505001
CHROME / CROMO

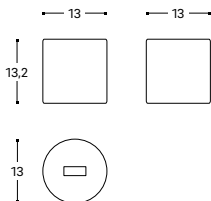

INCH 5.1x5.1x5.2



SQUARE TISSUE BOX
CAJA KLEENEX CUADRADA

WJP059A7506004
GOLD / ORO
WJP059A7506001
CHROME / CROMO

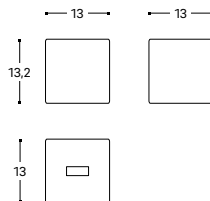

INCH 5.1x5.1x5.2



TISSUE BOX
CAJA KLEENEX

WJP059A9401004
GOLD / ORO
WJP059A9401001
CHROME / CROMO

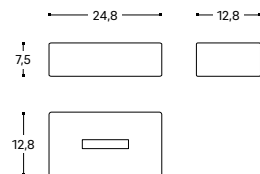

INCH 9.8x5x3



Black & White

Design by **Cosmic Studio**

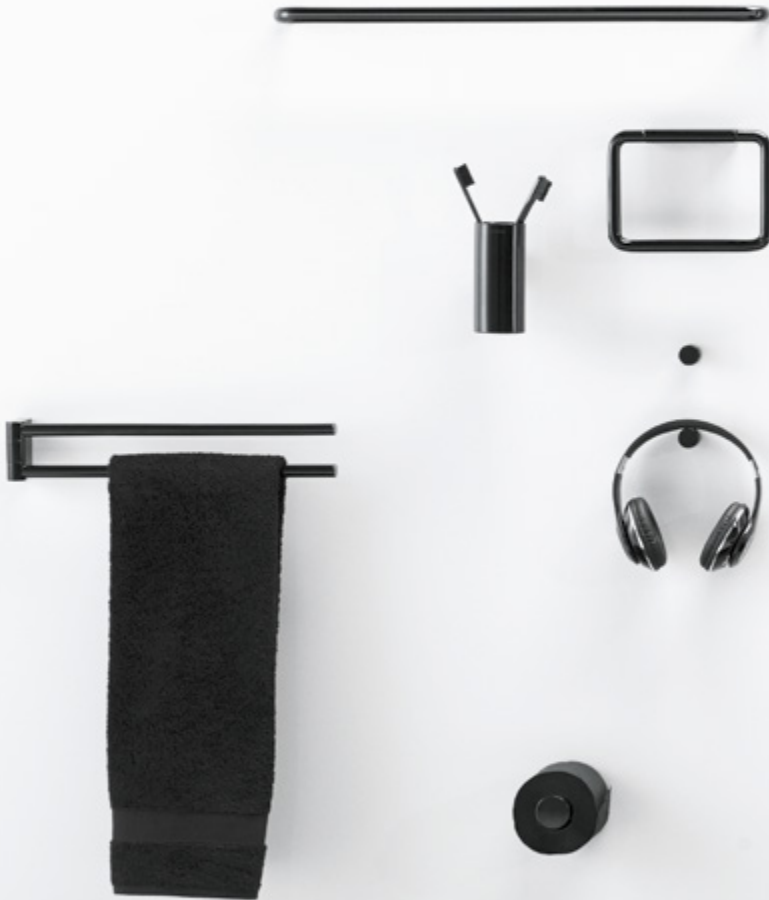





The classic colour contrast transforms the bathroom into a bold atmosphere or blends it in to the other components to create harmonious and diaphanous environments.

El contraste cromático más clásico permite transformar el baño en un ambiente atrevido o bien fundirse con el resto de elementos para convertir los entornos en armónicos y diáfanos.





Black & White

Design by Cosmic Studio





Black & White has successfully passed the high demanding tests of long last durability and resistance to extreme uses (static charge or impact testing) to assure long last durability of the product.

Toda la gama **Black & White** ha superado con éxito exigentes tests de durabilidad y resistencia a usos extremos (cargas estáticas o test de impacto), para asegurar una larga vida al producto.



FEATURES / CARACTERÍSTICAS

Easy installation: double pitch screw.
Hidden attachments. Anti-corrosion.
Lead free paint.

Fácil instalación: tornillo de doble paso.
Fijaciones ocultas. Anticorrosión.
Pintura libre de plomo.

FINISHES / ACABADOS



006
Glossy black
Negro brillo



005
Glossy white
Blanco brillo



036
Matte black
Negro mate

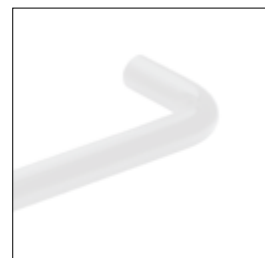

065
Matte white
Blanco mate

Black & White

Design by Cosmic Studio



⊙
HOOK
COLGADOR

WJC238A0021005
GLOSSY WHITE /BLANCO BRILLO

WJC238A0021006
GLOSSY BLACK /NEGRO BRILLO

Ⓢ **WJC238A0021065**
MATTE WHITE /BLANCO MATE

Ⓢ **WJC238A0021036**
MATTE BLACK /NEGRO MATE

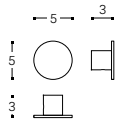

INCH 2x1.2x2



⊙
GLOVE HOOK
PORTAGUANTES

WJC238A0020005
GLOSSY WHITE /BLANCO BRILLO

WJC238A0020006
GLOSSY BLACK /NEGRO BRILLO

Ⓢ **WJC238A0020036**
MATTE BLACK /NEGRO MATE

WJC238A0020065
MATTE WHITE /BLANCO MATE

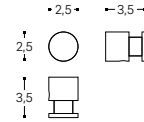

INCH 1x1.4x1



⊙△
FREE STANDING BRUSH-HOLDER
PORTACEPILLOS ENCIMERA

WJC238A0053005
GLOSSY WHITE /BLANCO BRILLO

WJC238A0053006
GLOSSY BLACK /NEGRO BRILLO

WJC238A0053065
MATTE WHITE /BLANCO MATE

Ⓢ **WJC238A0053036**
MATTE BLACK /NEGRO MATE

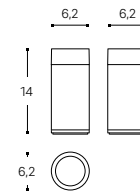

INCH 2.4x2.4x5.5



⊙△
BRUSH-HOLDER
PORTACEPILLOS

WJC238A0054005
GLOSSY WHITE /BLANCO BRILLO

WJC238A0054006
GLOSSY BLACK /NEGRO BRILLO

WJC238A0054065
MATTE WHITE /BLANCO MATE

Ⓢ **WJC238A0054036**
MATTE BLACK /NEGRO MATE

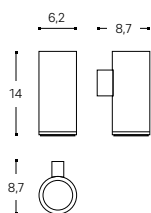

INCH 2.4x3.4x5.5



⊙
FREE STANDING SOAP DISPENSER
DOSIFICADOR ENCIMERA

WJC238A0004005
200 ML GLOSSY WHITE /BLANCO BRILLO

WJC238A0004006
200 ML GLOSSY BLACK /NEGRO BRILLO

WJC238A0004065
200 ML MATTE WHITE /BLANCO MATE

Ⓢ **WJC238A0004036**
200 ML MATTE BLACK /NEGRO MATE

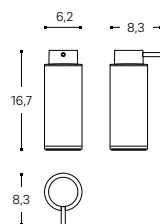

INCH 2.4x3.3x6.6



⊙
SOAP DISPENSER
DOSIFICADOR

WJC238A0005005
200 ML GLOSSY WHITE /BLANCO BRILLO

WJC238A0005006
200 ML GLOSSY BLACK /NEGRO BRILLO

WJC238A0005065
200 ML MATTE WHITE /BLANCO MATE

Ⓢ **WJC238A0005036**
200 ML MATTE BLACK /NEGRO MATE

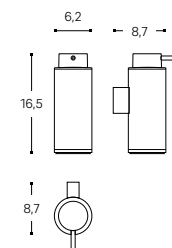

INCH 2.4x3.4x6.6





SHOWER SOAP DISH *
JABONERA DE DUCHA *

WJC238A0049005
GLOSSY WHITE /BLANCO BRILLO

WJC238A0049006
GLOSSY BLACK /NEGRO BRILLO

WJC238A0049065
MATTE WHITE /BLANCO MATE

WJC238A0049036
MATTE BLACK /NEGRO MATE

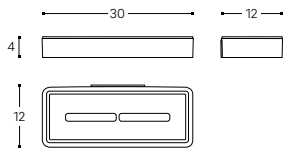

INCH 11.8x4.7x1.6

* CAN BE TAKEN APART FOR CLEANING.
* EXTRAÍBLES PARA SU LIMPIEZA.



FREE STANDING MAGNIFYING MIRROR
ESPEJO AUMENTO ENCIMERA

WJC238A0083005
(X3) GLOSSY WHITE /BLANCO BRILLO

WJC238A0083006
(X3) GLOSSY BLACK /NEGRO BRILLO

WJC238A0083065
(X3) MATTE WHITE /BLANCO MATE

WJC238A0083036
(X3) MATTE BLACK /NEGRO MATE

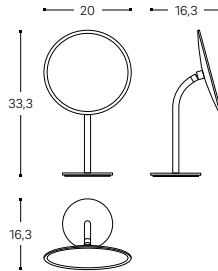

INCH 7.9x6.4x13.1



WALL MAGNIFYING MIRROR
ESPEJO DE AUMENTO PARED

WJC238A0085005
(X3) GLOSSY WHITE /BLANCO BRILLO

WJC238A0085006
(X3) GLOSSY BLACK /NEGRO BRILLO

WJC238A0085065
(X3) MATTE WHITE /BLANCO MATE

WJC238A0085036
(X3) MATTE BLACK /NEGRO MATE

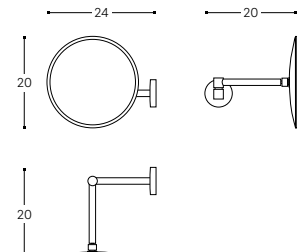

INCH 9.4x7.9x7.9



TOWEL RACK
TOALLERO

WJC238A0064005
40CM GLOSSY WHITE /BLANCO BRILLO

WJC238A0064006
40CM GLOSSY BLACK /NEGRO BRILLO

WJC238A0064065
40CM MATTE WHITE /BLANCO MATE

WJC238A0064036
40CM MATTE BLACK /NEGRO MATE

WJC238A0065005
60CM GLOSSY WHITE /BLANCO BRILLO

WJC238A0065006
60CM GLOSSY BLACK /NEGRO BRILLO

WJC238A0065065
60CM MATTE WHITE /BLANCO MATE

WJC238A0065036
60CM MATTE BLACK /NEGRO MATE

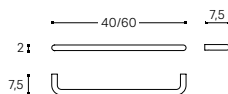

INCH 15.7/23.6x2.9x0.8



SWIVEL DOUBLE TOWEL RACK
TOALLERO GIRATORIO DOBLE

WJC238A0075005
GLOSSY WHITE /BLANCO BRILLO

WJC238A0075006
GLOSSY BLACK /NEGRO BRILLO

WJC238A0075065
MATTE WHITE /BLANCO MATE

WJC238A0075036
MATTE BLACK /NEGRO MATE

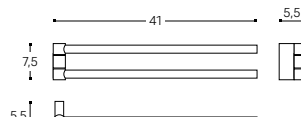

INCH 16.1x2.2x2.9



TOWEL RING
TOALLERO ARO

WJC238A0071005
GLOSSY WHITE /BLANCO BRILLO

WJC238A0071006
GLOSSY BLACK /NEGRO BRILLO

WJC238A0071065
MATTE WHITE /BLANCO MATE

WJC238A0071036
MATTE BLACK /NEGRO MATE

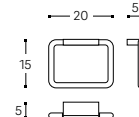

INCH 7.9x2x5.9

Black & White

Design by Cosmic Studio



⊙
TOWEL RACK SHELF
TOALLERO ESTANTE

- WJC238A0068005**
GLOSSY WHITE /BLANCO BRILLO
- WJC238A0068006**
GLOSSY BLACK /NEGRO BRILLO
- WJC238A0068065**
MATTE WHITE /BLANCO MATE
- WJC238A0068036**
MATTE BLACK /NEGRO MATE

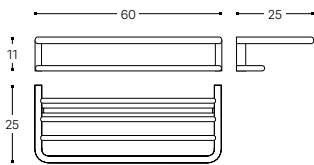

INCH 23.6x9.8x4.3



⊙○
PAPER HOLDER WITH COVER
PORTAPAPEL CON TAPA

- WJC238A0059005**
GLOSSY WHITE /BLANCO BRILLO
- WJC238A0059006**
GLOSSY BLACK /NEGRO BRILLO
- WJC238A0059065**
MATTE WHITE /BLANCO MATE
- WJC238A0059036**
MATTE BLACK /NEGRO MATE

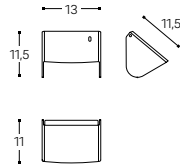

INCH 5.1x4.5x4.5



⊙
PAPER HOLDER WITHOUT COVER
PORTAPAPEL SIN TAPA

- WJC238A0158005**
GLOSSY WHITE /BLANCO BRILLO
- WJC238A0158006**
GLOSSY BLACK /NEGRO BRILLO
- WJC238A0158065**
MATTE WHITE /BLANCO MATE
- WJC238A0158036**
MATTE BLACK /NEGRO MATE

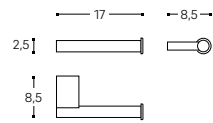

INCH 6.7x3.3x1



⊙
PAPER HOLDER WITHOUT COVER*
PORTAPAPEL SIN TAPA*

- WJC238A0058005**
GLOSSY WHITE /BLANCO BRILLO
- WJC238A0058006**
GLOSSY BLACK /NEGRO BRILLO
- WJC238A0058065**
MATTE WHITE /BLANCO MATE
- WJC238A0058036**
MATTE BLACK /NEGRO MATE

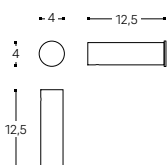

INCH 1.6x4.9x1.6



⊙○
FREE-STANDING OR WALL TOILET BRUSH
ESCOBILLERO SUELO/PARED

- WJC238A0000005**
GLOSSY WHITE /BLANCO BRILLO
- WJC238A0000006**
GLOSSY BLACK /NEGRO BRILLO
- WJC238A0000065**
MATTE WHITE /BLANCO MATE
- WJC238A0000036**
MATTE BLACK /NEGRO MATE

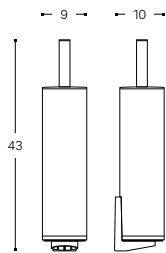

INCH 3.5x3.9x16.9



⊙○△
FREE STANDING TOILET BRUSH
ESCOBILLERO SUELO

- WJC235A0001036**
SOFT BLACK
- WJC235A0001065**
MATTE WHITE /BLANCO MATE

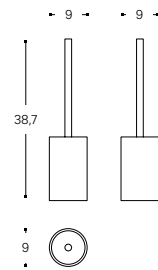

INCH 3.5x3.5x3.5





TOILET BRUSH
ESCOBILLERO

WJC235A0000036
SOFT BLACK

WJC235A0000065
MATTE WHITE / BLANCO MATE

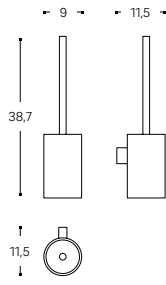

INCH 3.5x4.5x15.2



5L WASTE BIN
PAPELERA 5L

WJC277A0002065
MATTE WHITE / BLANCO MATE

WJC277A0002036
MATTE BLACK / NEGRO MATE

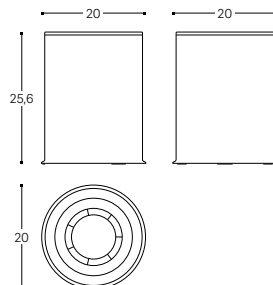

INCH 7.9x7.9x10.1

ALTA DISPONIBILIDAD.
HIGH AVAILABILITY.



STOOL
TABURETE

WJC277A0006065
WHITE / BLANCO

WJC277A0006036
BLACK / NEGRO

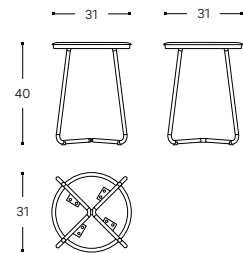

INCH 15.8x15.8x12.2



Diabolo

Design by Yang Ripol









Personalize your bathroom with proposals that move away from the traditional solutions.

Personaliza tu baño con propuestas que se alejan de lo tradicional.



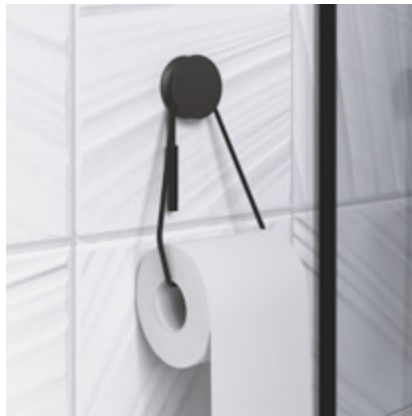

QUICK FIX / QUICK FIX

Our updated Diabolo collection now includes a dual installation system for installing bathroom accessories with or without a drill. Quick Fix adhesive, designed exclusively for our firm, means that bathroom accessories can be installed without drilling holes in the wall.

La colección Diabolo presenta como novedad el sistema de instalación dual, que permite sujetar los accesorios de baño con y sin taladros. Con el adhesivo Quick Fix, elaborado en exclusiva para la firma, se facilita el montaje sin la necesidad de hacer agujeros en la pared.

FEATURES / CARACTERÍSTICAS

Easy installation: double pitch screw. Hidden attachments. Anti-corrosion.

Fácil instalación: tornillo de doble paso. Fijaciones ocultas. Anticorrosión.

Diabolo has successfully passed the high demanding tests of long last durability and resistance to extreme uses (static charge or impact testing) to assure long last durability of the product. All products come with 10 years warranty.

Toda la gama **Diabolo** ha superado con éxito exigentes tests de durabilidad y resistencia a usos extremos (cargas estáticas o test de impacto), para asegurar una larga vida al producto. Todos los artículos tienen 10 años de garantía.



Easy installation without drilling

Fácil instalación sin taladro



Bonded with high adhesion adhesive (3M)

Fijación con adhesivo de alta adherencia (3M)

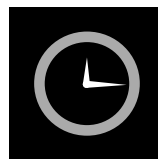

Quick, easy, silent installation

Montaje sin ruido, fácil y rápido

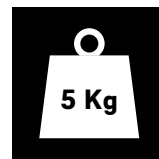

Static load of 5 kg

Carga estática de 5 KG



Do not use on painted surfaces and gypsum walls

No usar en superficies pintadas ni en paredes rugosas

FINISHES / ACABADOS



001
Chrome
Cromo



065
White
Blanco



036
Black
Negro



Black
Negro

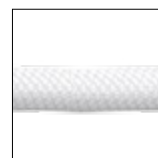

White
Blanco

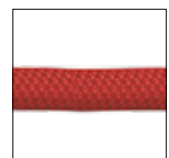

Red
Rojo





●
HOOK
 COLGADOR

- WJB275A0021001**
CHROME / CROMO
- WJB275A0021065**
WHITE / BLANCO
- WJB275A0021036**
BLACK / NEGRO

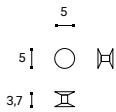

INCH Ø 2x1.5

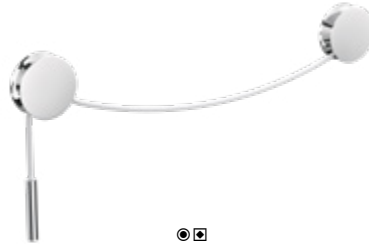

●◻
TOWEL RACK
 TOALLERO

- WJB275A0064001**
CHROME - BLACK / CROMO - NEGRO
- WJB275A1064001**
CHROME - WHITE / CROMO - BLANCO
- WJB275A2064001**
CHROME - RED / CROMO - ROJO

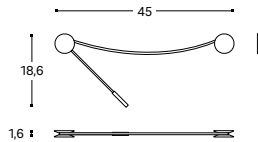

INCH Ø 2x0.7

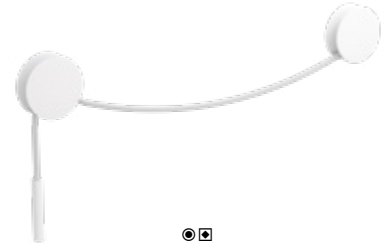

●◻
TOWEL RACK
 TOALLERO

- WJB275A0064065**
WHITE - BLACK / BLANCO - NEGRO
- WJB275A1064065**
WHITE - WHITE / BLANCO - BLANCO
- WJB275A2064065**
WHITE - RED / BLANCO - ROJO

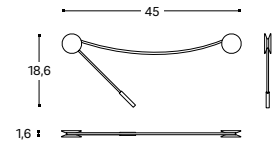

INCH Ø 2x0.7

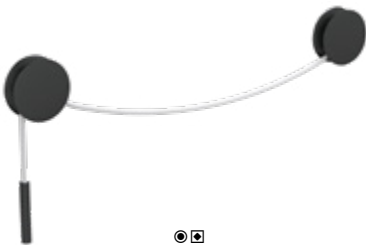

●◻
TOWEL RACK
 TOALLERO

- WJB275A0064036**
BLACK - BLACK / NEGRO - NEGRO
- WJB275A1064036**
BLACK - WHITE / NEGRO - BLANCO
- WJB275A2064036**
BLACK - RED / NEGRO - ROJO

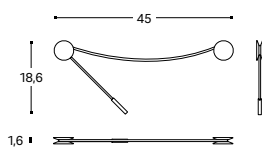

INCH Ø 2x0.7



●◻
PAPER HOLDER WITHOUT COVER
 PORTAPAPEL SIN TAPA

- WJB275A0058001**
CHROME - BLACK / CROMO - NEGRO
- WJB275A1058001**
CHROME - WHITE / CROMO - BLANCO
- WJB275A2058001**
CHROME - RED / CROMO - ROJO

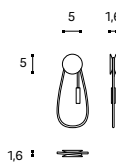

INCH 8.5x8.6x2.9



●◻
PAPER HOLDER WITHOUT COVER
 PORTAPAPEL SIN TAPA

- WJB275A0058065**
WHITE - BLACK / BLANCO - NEGRO
- WJB275A1058065**
WHITE - WHITE / BLANCO - BLANCO
- WJB275A2058065**
WHITE - RED / BLANCO - ROJO

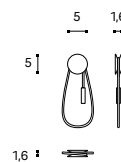

INCH Ø 2x0.7





PAPER HOLDER WITHOUT COVER
PORTAPAPEL SIN TAPA

WJB275A0058036
BLACK - BLACK / NEGRO - NEGRO

WJB275A1058036
BLACK - WHITE / NEGRO - BLANCO

WJB275A2058036
BLACK - RED / NEGRO - ROJO

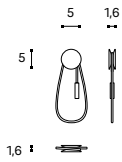

INCH Ø 2x0.7



Duo

Design by Raúl Ruiz









Make better use of your space;
put an accessory wherever you need it.

Aprovecha mejor tu espacio,
coloca un accesorio allí donde lo necesites.



Forget about drilling walls;
get the most out of them.

Olvídate de agujerear las paredes,
sácales el máximo partido.







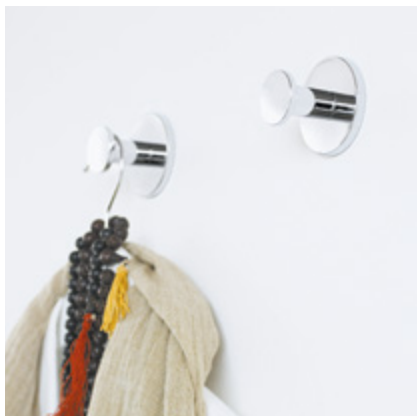

QUICK FIX / QUICK FIX

Our Duo collection includes a installation system for installing bathroom accessories without a drill. Quick Fix adhesive, designed exclusively for our firm, means that bathroom accessories can be installed without drilling holes in the wall.

La colección Duo presenta como novedad el sistema de instalación Quick Fix, que permite sujetar los accesorios de baño sin taladros. Con el adhesivo Quick Fix, elaborado en exclusiva para la firma, se facilita el montaje sin la necesidad de hacer agujeros en la pared.

FEATURES / CARACTERÍSTICAS

Easy installation.
Anti-corrosion.

Fácil instalación.
Anticorrosión.

Duo has successfully passed the high demanding tests of long last durability and resistance to extreme uses (static charge or impact testing) to assure long last durability of the product. All products come with 10 years warranty.

Toda la gama **Duo** ha superado con éxito exigentes tests de durabilidad y resistencia a usos extremos (cargas estáticas o test de impacto), para asegurar una larga vida al producto. Todos los artículos tienen 10 años de garantía.

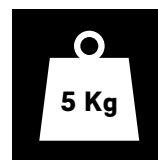
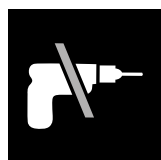
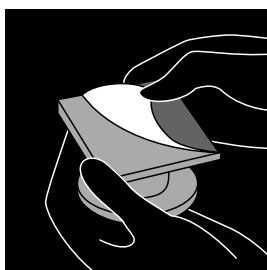

Easy installation without drilling

Fácil instalación sin taladro

Bonded with high adhesion adhesive

Fijación con adhesivo de alta adherencia

Quick, easy, silent installation

Montaje sin ruido, fácil y rápido

Static load of 5 kg

Carga estática de 5 KG

Do not use on painted surfaces and gypsum walls

No usar en superficies pintadas ni en paredes rugosas

**QUICK
FIX**

FINISHES / ACABADOS



Duo Round



Duo Square



Duo Round

Design by Raúl Ruiz



⊙
HOOK
COLGADOR

Ⓢ **WJB262A0021001**

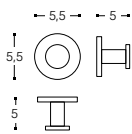

INCH 2.2x2x2.2



◇⊙
SOAP DISH
JABONERA

WJB262A0032001

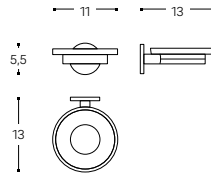

INCH 4.3x5.1x2.2



◇⊙
BRUSH-HOLDER
PORTACEPILLOS

WJB262A0052001

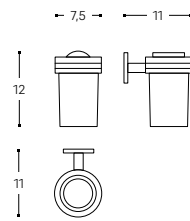

INCH 2.9x4.3x4.7



◇⊙
SOAP DISPENSER
DOSIFICADOR

WJB262A0005001
200 ML

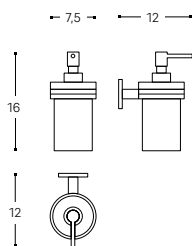

INCH 2.9x4.7x6.3



⊙
SOAP DISPENSER
DOSIFICADOR

WJB262A0004001
240 ML

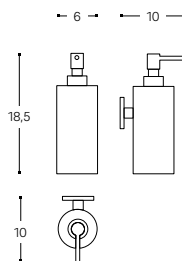

INCH 2.4x3.9x7.3



⊙⊙
SOAP WIRE BASKET
JABONERA DE DUCHA

WJB262A0049001

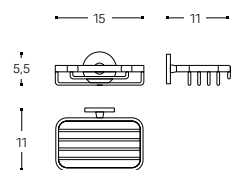

INCH 5.9x4.3x2.2



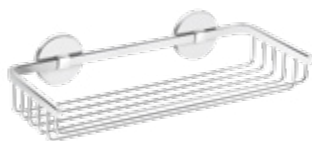

SOAP WIRE BASKET
JABONERA DE DUCHA

WJB262A0030001
20 CM / INCH 7.9

WJB262A0033001
30 CM / INCH 11.8

WJB262A0048001
40 CM / INCH 15.8

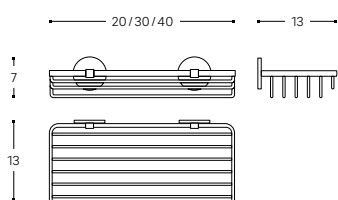

INCH 7.9/11.8/15.8x5.1x2.7

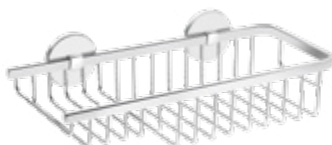

SOAP WIRE BASKET
JABONERA DE DUCHA

WJB262A0088001

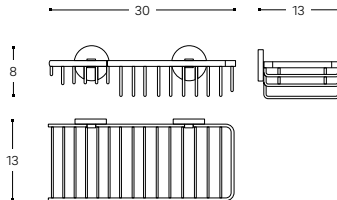

INCH 11.8x5.1x3.1

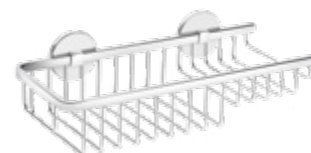

SOAP WIRE BASKET
JABONERA DE DUCHA

WJB262A0087001

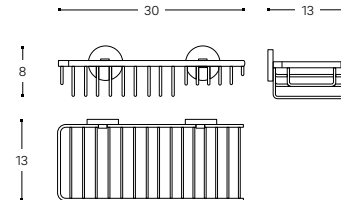

INCH 11.8x5.1x3.1

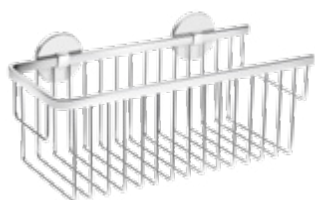

SOAP WIRE BASKET
JABONERA DE DUCHA

WJB262A0042001

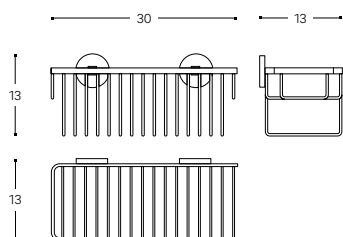

INCH 11.8x5.1x5.1



CORNER SHOWER WIRE BASKET
JABONERA DE DUCHA RINCÓN

WJB262A0050001

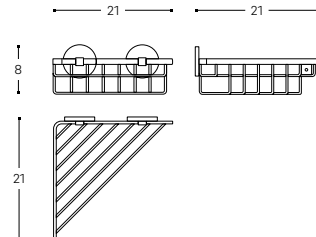

INCH 10.2x10.2x3.1



CORNER SHOWER WIRE BASKET
JABONERA DE DUCHA RINCÓN

WJB262A0089001
8 CM / INCH 3.1

WJB262A0041001
13 CM / INCH 5.1

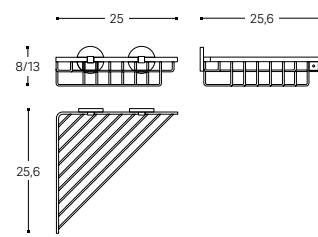

INCH 10.2x10.2x3.1/5.1

Duo Round

Design by Raúl Ruiz



○●
TOWEL RING
TOALLERO ARO

WJB262A0072001

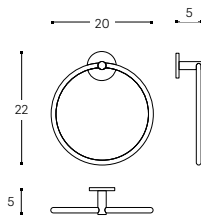

INCH 7.8x2x8.7



○●
TOWEL RACK
TOALLERO

- S **WJB262A0063001**
30 CM / INCH 11.8
- S **WJB262A0064001**
45 CM / INCH 17.7
- S **WJB262A0065001**
60 CM / INCH 23.6

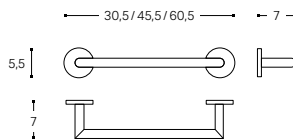

INCH 12/17.9/23.8x2.7x2.2



◆●
GLASS SHELF
ESTANTE VIDRIO

- WJB262A0044001**
40 CM / INCH 15.7
- WJB262A0045001**
60 CM / INCH 23.6

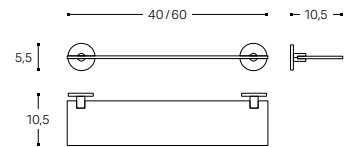

INCH 15.7/23.6x4.1x2



○●
TOWEL RACK SHELF
TOALLERO ESTANTE

WJB262A0068001

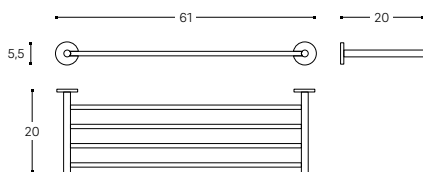

INCH 24x7.9x2.2



○
PAPER HOLDER WITHOUT COVER
PORTAPAPEL SIN TAPA

- S **WJB262A0056001**
RIGHT / DERECHA
- S **WJB262A0057001**
LEFT / IZQUIERDA

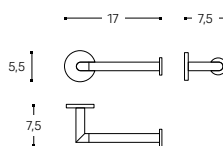

INCH 6.7x2.9x2.2



○●
RIGHT PAPER HOLDER WITH COVER
PORTAPAPEL CON TAPA DERECHO

WJB262A0059001

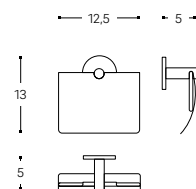

INCH 4.9x2x5.1





TOILET BRUSH
ESCOBILLERO

WJB262A0000001

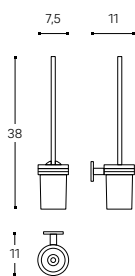

INCH 2.9x3.9x15



TOILET BRUSH
ESCOBILLERO

WJB262A0001001

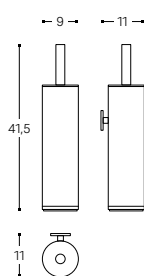

INCH 3.5x4.3x16.3



Duo Square

Design by Raúl Ruiz



⊙
HOOK
COLGADOR

S WJB264A0021001

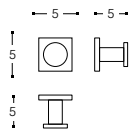

INCH 2.2x2x2.2



◇⊙
SOAP DISH
JABONERA

WJB264A0032001

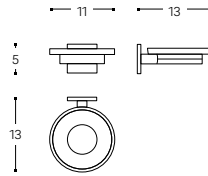

INCH 4.3x5.1x2.2



◇⊙
BRUSH-HOLDER
PORTACEPILLOS

WJB264A0052001

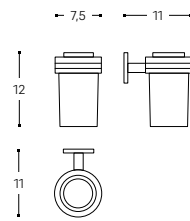

INCH 2.9x4.3x4.7



◇⊙
SOAP DISPENSER
DOSIFICADOR

WJB264A0005001
200 ML

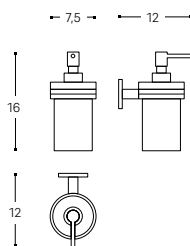

INCH 2.9x4.7x6.3



⊙
SOAP DISPENSER
DOSIFICADOR

WJB264A0004001
240 ML

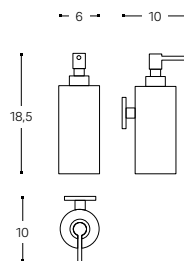

INCH 2.4x3.9x7.3



⊙⊙
SOAP WIRE BASKET
JABONERA DE DUCHA

WJB264A0049001

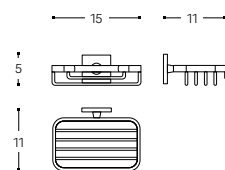

INCH 5.9x4.3x2.2



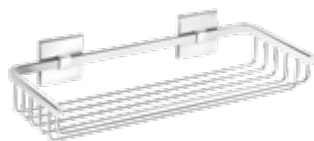

SOAP WIRE BASKET
JABONERA DE DUCHA

WJB262A0030001
20 CM / INCH 7.9

WJB262A0033001
30 CM / INCH 11.8

WJB262A0048001
40 CM / INCH 15.8

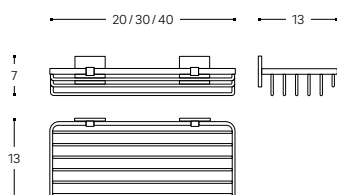

INCH 7.9/11.8/15.8x5.1x2.7

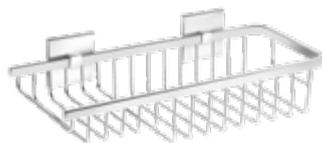

SOAP WIRE BASKET
JABONERA DE DUCHA

WJB264A0088001

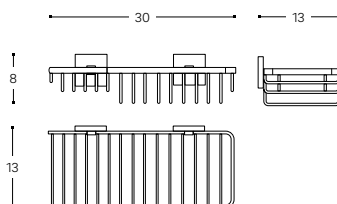

INCH 11.8x5.1x3.1

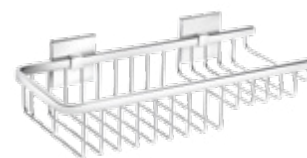

SOAP WIRE BASKET
JABONERA DE DUCHA

WJB264A0087001

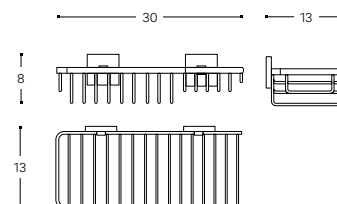

INCH 11.8x5.1x3.1

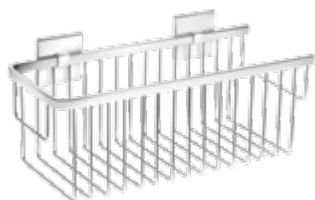

SOAP WIRE BASKET
JABONERA DE DUCHA

WJB264A0042001

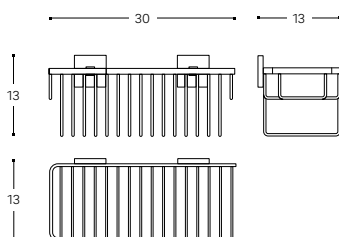

INCH 11.8x5.1x5.1



CORNER SHOWER WIRE BASKET
JABONERA DE DUCHA RINCÓN

WJB264A0050001

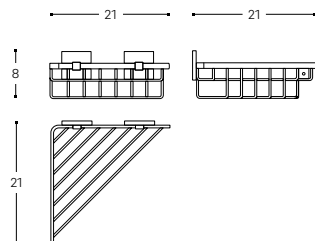

INCH 10.2x10.2x3.1



CORNER SHOWER WIRE BASKET
JABONERA DE DUCHA RINCÓN

WJB264A0089001
8 CM / INCH 3.1

WJB264A0041001
13 CM / INCH 5.1

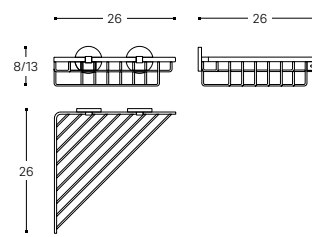

INCH 10.2x10.2x3.1/5.1

Duo Square

Design by Raúl Ruiz



○●
TOWEL RING
TOALLERO ARO

WJB264A0072001

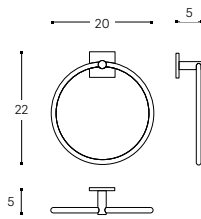

INCH 7.8x2x8.7



○●
TOWEL RACK
TOALLERO

- S **WJB264A0063001**
30 CM / INCH 11.8
- S **WJB264A0064001**
45 CM / INCH 17.7
- S **WJB264A0065001**
60 CM / INCH 23.6

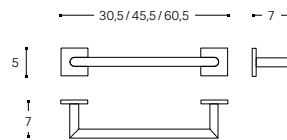

INCH 12/17.9/23.8x2.7x2.2



◆●
GLASS SHELF
ESTANTE VIDRIO

- WJB264A0044001**
40 CM / INCH 15.7
- WJB264A0045001**
60 CM / INCH 23.6

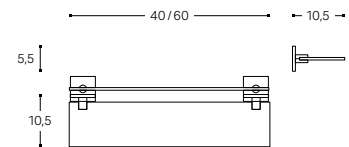

INCH 15.7/23.6x4.1x2



○●
TOWEL RACK SHELF
TOALLERO ESTANTE

WJB264A0068001

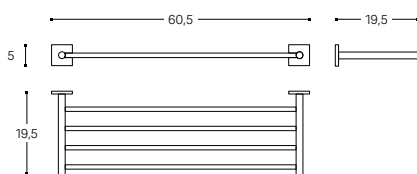

INCH 24x7.9x2.2



○
PAPER HOLDER WITHOUT COVER
PORTAPAPEL SIN TAPA

- S **WJB264A0056001**
RIGHT / DERECHA
- S **WJB264A0057001**
LEFT / IZQUIERDA

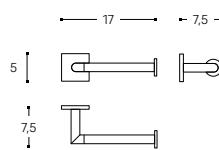

INCH 6.7x2.9x2.2



○●
RIGHT PAPER HOLDER WITH COVER
PORTAPAPEL CON TAPA DERECHO

WJB264A0059001

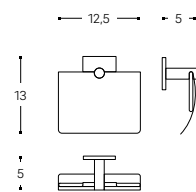

INCH 4.9x2x5.1





TOILET BRUSH
ESCOBILLERO

WJB264A0000001

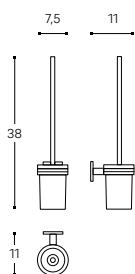

INCH 2.9x3.9x15



TOILET BRUSH
ESCOBILLERO

WJB264A0001001

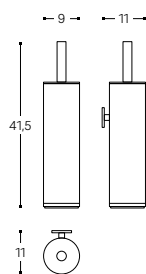

INCH 3.5x4.3x16.3



Eda

Design by Lázaro Rosa-Violán





Metal and wood accessories that coexist in perfect harmony in a bathroom with a landscape design.

Accesorios metálicos y de madera que conviven en perfecta armonía en un baño de concepción paisajista.











Simply allow yourself to be swept away,
and enter a private, nocturnal atmosphere.
It's the time to discover some accessories
designed to ensure maximum well-being.

Solo hay que dejarse llevar y entrar en una
atmósfera privada y nocturna. Es el momento
de descubrir unos accesorios pensados para
conseguir el máximo bienestar.







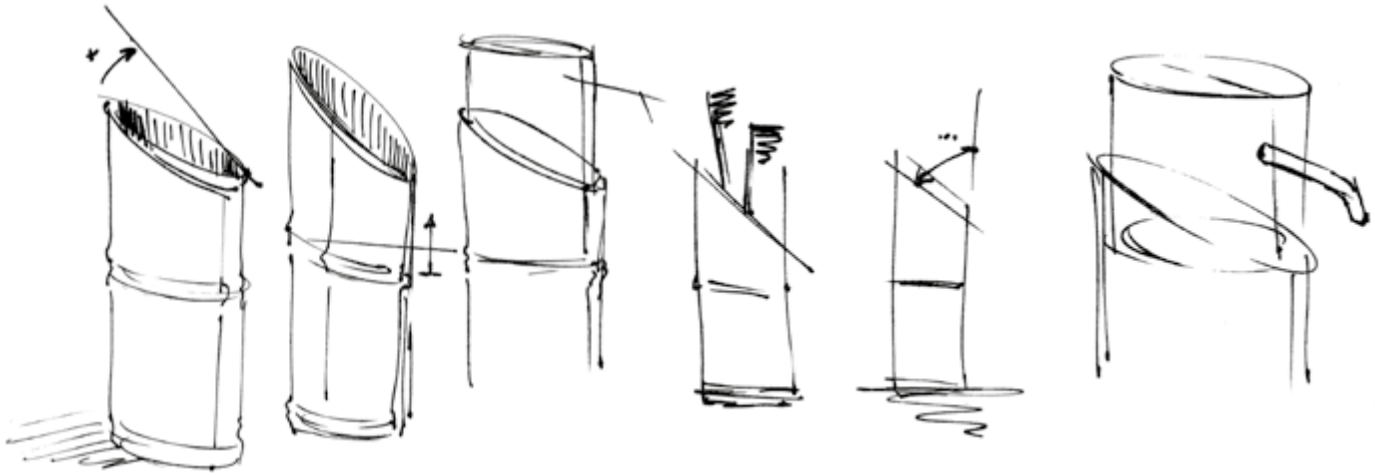

About Lázaro Rosa-Violán

In 2002, a passion for design led Lázaro Rosa-Violán to found his own studio, which would call an old textile factory in Barcelona home. It is a space where professionals from different disciplines and of different nationalities coexist, forming a team consisting of architects, interior designers, industrial designers and graphic artists and engineers.

The studio has experienced spectacular growth, developing projects on a national and international level, creating an impressive portfolio of clients, implementing all types of projects in over 40 countries: luxury hotels, boutique hotels, large resorts, all types of restaurants and retail spaces. All of this is done in the company of great brands like Inditex, for which it has developed the image for Oysho, Pull & Bear and Lefties; Aristocrazy for Joyerías Suarez, Soho House, Mondrian, Berns Group Hotels Stockholm, Iberica Restaurantes, H10 Hoteles, NH Hoteles, Sandy Lane Canouan and Marriot.

A painter by trade, traveller by conviction and interior designer by instinct, Lázaro finds inspiration everywhere. His style encompasses all the styles; his cultural baggage permits him to mix, modify and reinterpret trends from the past and present, as appropriate for each new commission.

In 2013, Lázaro was honoured by Architectural Digest Spain as the best interior designer in Europe, and for the fifth consecutive year, he was named one of the 100 best interior designers around the world by the Architectural Digest French collectors.

Sobre Lázaro Rosa-Violán

En 2002, la pasión por el diseño llevó a Lázaro Rosa-Violán a fundar su propio estudio, el cual emplazaría en una antigua fábrica textil de Barcelona. Un espacio en el que conviven profesionales de diferentes disciplinas y nacionalidades, formando un equipo compuesto por arquitectos, interioristas, diseñadores industriales y gráficos e ingenieros.

El estudio ha sufrido un crecimiento espectacular, desarrollando proyectos a nivel nacional e internacional, creando una impresionante cartera de clientes, desarrollando todo tipo de proyectos en más de 40 países: hoteles de lujo, hotel boutiques, grandes resorts, todo tipo de restaurantes y espacios de retail. Todo ello acompañado de grandes marcas como Inditex para quien ha desarrollado la imagen de Oysho, Pull & Bear o Lefties; Aristocrazy de Joyerías Suarez, Soho House, Mondrian, Berns Group Hotels Stockholm, Iberica Restaurantes, H10 Hoteles, NH Hoteles, Sandy Lane Canouan o Marriot.

Pintor de formación, viajante por convicción y diseñador de interiores por instinto, Lázaro encuentra inspiración en todas partes. Su estilo son todos los estilos; su bagaje cultural le permite mezclar, modificar y reinterpretar tendencias del pasado y del presente según le convenga en cada nuevo encargo.

En 2013 Lázaro fue honrado por Architectural Digest España como el mejor diseñador de interiores en Europa y por quinto año consecutivo, ha sido uno de los 100 mejores diseñadores de interiores a nivel mundial por la Architectural Digest coleccionistas de Francia.

3
YEARS GUARANTEE
AÑOS GARANTÍA
BAMBOO

10
YEARS GUARANTEE
AÑOS GARANTÍA
CHROME / BLACK



Eda has successfully passed the high demanding tests of long last durability and resistance to extreme uses (static charge or impact testing) to assure long last durability of the product.

Toda la gama Eda ha superado con éxito exigentes tests de durabilidad y resistencia a usos extremos (cargas estáticas o test de impacto), para asegurar una larga vida al producto.

FEATURES / CARACTERÍSTICAS

Easy installation: double pitch screw.
Hidden attachments.

Fácil instalación: tornillo de doble paso.
Fijaciones ocultas.

FINISHES / ACABADOS



001
Chrome
Cromo



000
Natural
Bamboo
Bambú
Natural



001
Natural
Bamboo-
Chrome
Bambú
Natural-
Cromo



603
Natural
Bamboo-
Matte Black
Bambú
Natural-Negro
Mate



036
Matte Black
Negro Mate



036
Black
Bamboo
Bambú
Negro



602
Black
Bamboo-
Chrome
Bambú
Negro-
Cromo



036
Black
Bamboo-
Matte Black
Bambú Negro-
Negro Mate





HOOK
COLGADOR

WJP056A3011001
CHROME / CROMO
WJP056A3011036
MATTE BLACK / NEGRO MATE

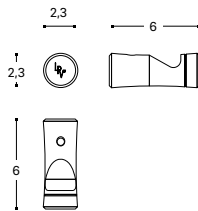

INCH 0.9x2.4x0.9



TOWEL RACK
TOALLERO

WJP056A1030001
30 CM / INCH 15.5 CHROME / CROMO
WJP056A1045001
40 CM / INCH 15.5 CHROME / CROMO
WJP056A1060001
60 CM / INCH 23.4 CHROME / CROMO
WJP056A1030036
30 CM / INCH 15.5 MATTE BLACK / NEGRO MATE
WJP056A1045036
40 CM / INCH 15.5 MATTE BLACK / NEGRO MATE
WJP056A1060036
60 CM / INCH 23.4 MATTE BLACK / NEGRO MATE

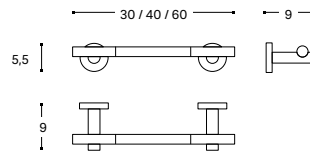

INCH 11/16.9/23.6x3.5x2.2



TOWEL RING
TOALLERO ARO

WJP056A2005001
CHROME / CROMO
WJP056A2005036
MATTE BLACK / NEGRO MATE

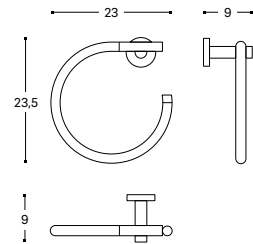

INCH 9.1x3.51x9.1



TOWEL RACK SHELF
TOALLERO ESTANTE

WJP056A5110001
CHROME / CROMO
WJP056A5110036
MATTE BLACK / NEGRO MATE

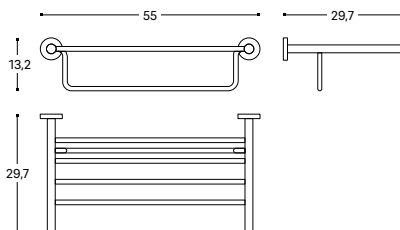

INCH 21.7x11.7x5.2



SOAP WIRE BASKET
JABONERA DE DUCHA

WJP056A6020001
NATURAL BAMBOO-CHROME /
BAMBU NATURAL-CROMO
WJP056A6020603
NATURAL BAMBOO-MATTE BLACK /
BAMBU NATURAL-NEGRO MATE
WJP056A6020602
BLACK BAMBOO-CHROME /
BAMBU NEGRO-CROMO
WJP056A6020036
BLACK BAMBOO-MATTE BLACK /
BAMBU NEGRO-NEGRO MATE

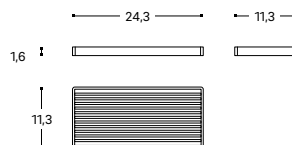

INCH 9.6x1.9x4.4



CORNER SHOWER WIRE BASKET
JABONERA DE DUCHA RINCÓN

WJP056A6030001
NATURAL BAMBOO-CHROME /
BAMBU NATURAL-CROMO
WJP056A6030603
NATURAL BAMBOO-MATTE BLACK /
BAMBU NATURAL-NEGRO MATE
WJP056A6030602
BLACK BAMBOO-CHROME /
BAMBU NEGRO-CROMO
WJP056A6030036
BLACK BAMBOO-MATTE BLACK /
BAMBU NEGRO-NEGRO MATE

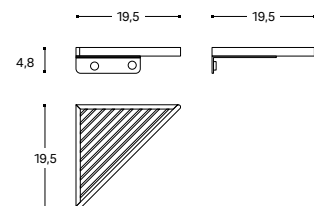

INCH 7.7x1.9x7.6





○ ●
 PAPER HOLDER WITHOUT COVER
 PORTAPAPEL SIN TAPA

WJP056A4001001
 CHROME / CROMO
WJP056A4001036
 MATTE BLACK / NEGRO MATE

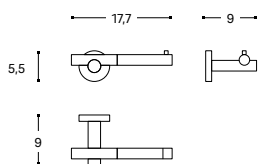

INCH 6.9x3.5x2.2



○ ●
 PAPER HOLDER WITH COVER
 PORTAPAPEL CON TAPA

WJP056A4002001
 CHROME / CROMO
WJP056A4002036
 MATTE BLACK / NEGRO MATE

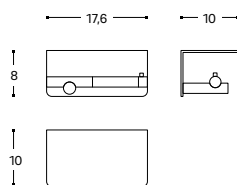

INCH 6.9x3.9x3.2



●
 TOILET BRUSH
 ESCOBILLERO

WJP056A9001001
 CHROME / CROMO
WJP056A9001036
 MATTE BLACK / NEGRO MATE

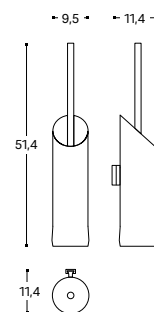

INCH 3.7x4.5x20.1



●
 FREE STANDING TOILET BRUSH
 ESCOBILLERO SUELO

WJP056A9050001
 CHROME / CROMO
WJP056A9050036
 MATTE BLACK / NEGRO MATE

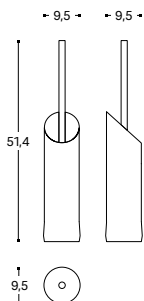

INCH 3.7x3.7x20.1



●
 BRUSH-HOLDER
 PORTACEPILLOS

WJP056A7001001
 CHROME / CROMO
WJP056A7001036
 MATTE BLACK / NEGRO MATE

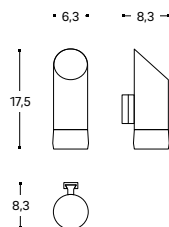

INCH 2.5x3.2x6.9



●
 FREE STANDING BRUSH-HOLDER
 PORTACEPILLOS ENCIMERA

WJP056A7050001
 CHROME / CROMO
WJP056A7050036
 MATTE BLACK / NEGRO MATE

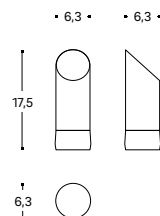

INCH 2.5x2.5x6.9





SOAP DISPENSER
DOSIFICADOR

WJP056A7801001
185 ML CHROME / CROMO
WJP056A7801036
185 ML MATTE BLACK / NEGRO MATE

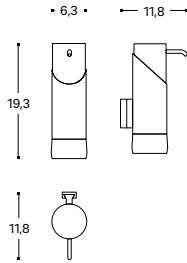

INCH 2.5x4.3x8.3



FREE STANDING SOAP DISPENSER
DOSIFICADOR ENCIMERA

WJP056A7831001
185 ML CHROME / CROMO
WJP056A7831036
185 ML MATTE BLACK / NEGRO MATE

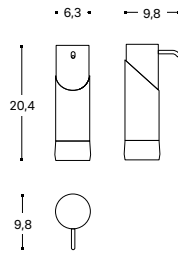

INCH 2.5x3.9x8.3



DISH
BANDEJA

WJP056A9701000
NATURAL BAMBOO / BAMBÚ NATURAL
WJP056A9701036
BLACK BAMBOO / BAMBÚ NEGRO

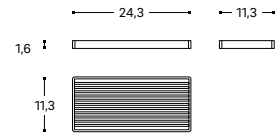

INCH 9.6x0.6x4.5



TISSUE BOX
CAJA KLEENEX

WJP056A9401001
NATURAL BAMBOO-CHROME /
BAMBÚ NATURAL-CROMO
WJP056A9401603
NATURAL BAMBOO-MATTE BLACK /
BAMBÚ NATURAL-NEGRO MATE
WJP056A9401602
BLACK BAMBOO-CHROME /
BAMBÚ NEGRO-CROMO
WJP056A9401036
BLACK BAMBOO-MATTE BLACK /
BAMBÚ NEGRO-NEGRO MATE

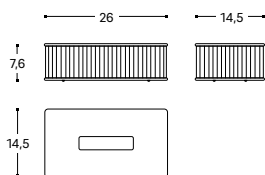

INCH 10.2x2.9x5.7



WASTE WITHOUT LID
PAPELERA SIN TAPA

WJP056A9351001
NATURAL BAMBOO-CHROME /
BAMBÚ NATURAL-CROMO
WJP056A9351603
NATURAL BAMBOO-MATTE BLACK /
BAMBÚ NATURAL-NEGRO MATE
WJP056A9351602
BLACK BAMBOO-CHROME /
BAMBÚ NEGRO-CROMO
WJP056A9351036
BLACK BAMBOO-MATTE BLACK /
BAMBÚ NEGRO-NEGRO MATE

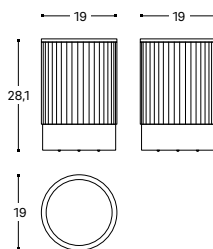

INCH 7.2x7.5x11



WASTE BIN
PAPELERA

WJP056A9350001
NATURAL BAMBOO-CHROME /
BAMBÚ NATURAL-CROMO
WJP056A9350603
NATURAL BAMBOO-MATTE BLACK /
BAMBÚ NATURAL-NEGRO MATE
WJP056A9350602
BLACK BAMBOO-CHROME /
BAMBÚ NEGRO-CROMO
WJP056A9350036
BLACK BAMBOO-MATTE BLACK /
BAMBÚ NEGRO-NEGRO MATE

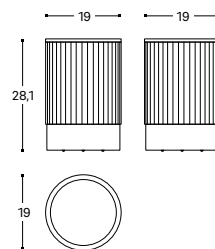

INCH 7.2x7.5x11



Equilibrium

Design by **Edward van Vliet**









A rosette of corrugated porcelain seems to carry the metal bar giving shape to an elegant towel rack. Pure craftsmanship that follows a careful process.

Un rosetón de porcelana rayada se ensambla a la barra metálica dando forma a un elegante toallero. Artesanía pura que sigue un cuidado proceso.





Shower basket with natural stone ledge hanging from two porcelain hooks. A new classic, with accessories dressed in special patterns and textures.

Cesta de ducha con repisa piedra natural que pende de dos perchas de porcelana. Un nuevo clásico crepuscular, con complementos vestidos de patrones y texturas especiales.

Equilibrium

Design by Edward van Vliet





FEATURES / CARACTERÍSTICAS

Hidden attachments. Anti-Corrosion. Lead free matte paint. Shelves & glasses made of acrylic glass.

Fijaciones ocultas. Anticorrosión. Pintura mate libre de plomo. Estantes y vasos fabricados en cristal acrílico.

Accessories with a ground-breaking, functional design. A commitment to innovation and modernity.

Accesorios con un diseño rompedor y funcional. Una apuesta por la innovación y la modernidad.

Equilibrium has successfully passed the high demanding tests of long last durability and resistance to extreme uses (static charge or impact testing) to assure long last durability of the product.

Toda la gama **Equilibrium** ha superado con éxito exigentes tests de durabilidad y resistencia a usos extremos (cargas estáticas o test de impacto), para asegurar una larga vida al producto.

FINISHES / ACABADOS

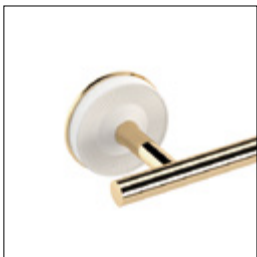

001
Gold
Oro

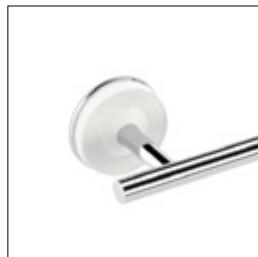

002
Chrome
Cromo



007
Bronze
Bronce

TEXTURES / TEXTURAS



Hexagon matte white
Hexágono blanco mate

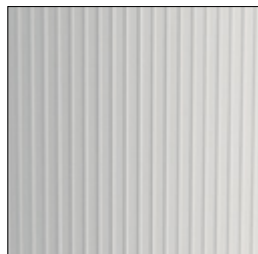

Ribs matte white
Rayas blanco mate

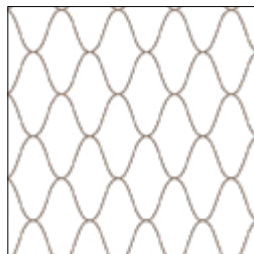

Netting bright white
Netting blanco brillo

PATTERN / DECORADO

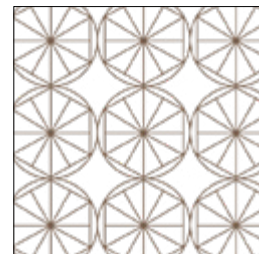

Circles bright white
Circles blanco brillo



Equilibrium

Design by Edward van Vliet



⊙⊗
HOOK
COLGADOR

- WJP077A3011001**
MATTE WHITE-CHROME / BLANCO MATE-CROMO
- WJP077A3011004**
MATTE WHITE-GOLD/ BLANCO MATE-ORO
- WJP077A3011007**
MATTE WHITE-BRONZE / BLANCO MATE-BRONCE

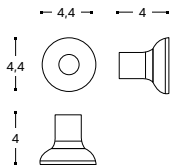

INCH 1.7x1.6x1.7



⊙⊗
HOOK
COLGADOR

- WJP077A3001001**
MATTE WHITE-CHROME / BLANCO MATE-CROMO
- WJP077A3001004**
MATTE WHITE-GOLD/ BLANCO MATE-ORO
- WJP077A3001007**
MATTE WHITE-BRONZE / BLANCO MATE-BRONCE

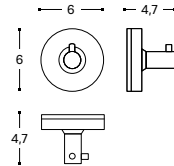

INCH 2.4x1.9x2.4



⊙⊗⊗
RACK SOAP DISH
JABONERA REJILLA

- WJP077A6001001**
MATTE WHITE-CHROME / BLANCO MATE-CROMO
- WJP077A6001004**
MATTE WHITE-GOLD/ BLANCO MATE-ORO
- WJP077A6001007**
MATTE WHITE-BRONZE / BLANCO MATE-BRONCE

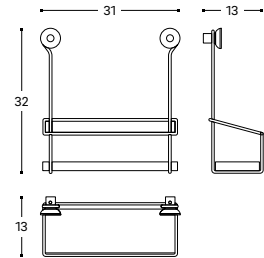

INCH 12.2x5.2x12.7



⊗
FREE STANDING SOAP DISH
JABONERA ENCIMERA

- WJP077A6050001**
GLOSSY WHITE-PLATINUM / BLANCO BRILLO-PLATINO
- WJP077A6050004**
GLOSSY WHITE-GOLD/ BLANCO BRILLO-ORO
- WJP077A6050541**
GLOSSY CELADON-PLATINUM / CELADON BRILLO-PLATINO
- WJP077A6050544**
GLOSSY CELADON-GOLD / CELADON BRILLO-ORO

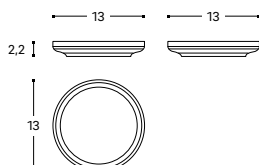

INCH 5.1x5.1x0.9



⊙⊗⊗
FREE STANDING BRUSH HOLDER
PORTACEPILLOS ENCIMERA

- ⊗ **WJP077A7056500**
- ⊗ **WJP077A7058500**
WHITE / BLANCO
- ⊗ **WJP077A7056540**
- ⊗ **WJP077A7058540**
CELADON / CELADON
- ⊗ **WJP077A7055501**
- ⊗ **WJP077A7057501**
WHITE-PLATINUM / BLANCO-PLATINO
- ⊗ **WJP077A7055504**
- ⊗ **WJP077A7057504**
WHITE-GOLD / BLANCO-ORO

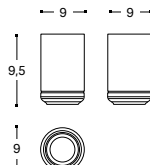

INCH 12.2x5.2x12.7



⊗
DISH
BANDEJA

- WJP077A1040001**
MATTE WHITE-CHROME / BLANCO MATE-CROMO
- WJP077A1040004**
MATTE WHITE-GOLD/ BLANCO MATE-ORO

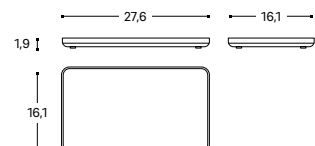

INCH 10.09x6.3x0.8



FREE STANDING SOAP DISPENSER
DOSIFICADOR ENCIMERA

- WJP077A7835501
- WJP077A7836501
- WJP077A7837501
- WJP077A7838501
- WHITE-CHROME / BLANCO-CROMO
- WJP077A7836541
- WJP077A7838541
- CELADON-CHROME / CELADON-CROMO
- WJP077A783504
- WJP077A7836504
- WJP077A7837504
- WJP077A7838504
- WHITE-GOLD / BLANCO-ORO
- WJP077A7836544
- WJP077A7838544
- CELADON-GOLD / CELADON-CROMO
- WJP077A783507
- WJP077A7836507
- WJP077A7837507
- WJP077A7838507
- WHITE-BRONZE / BLANCO-BRONCE
- WJP077A7836547
- WJP077A7838547
- CELADON-BRONZE / CELADON-BRONCE

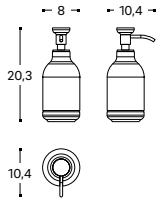

INCH 7.2x1.6x10



TISSUE BOX
CAJA KLEENEX

- WJP077A9401001
- MATTE WHITE-CHROME / BLANCO MATE-CROMO
- WJP077A9401004
- MATTE WHITE-GOLD/ BLANCO MATE-ORO
- WJP077A9401007
- MATTE WHITE-BRONZE / BLANCO MATE-BRONCE

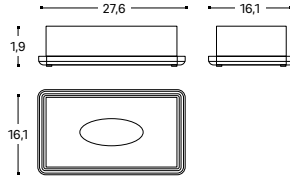

INCH 10.9x6.3x3



FREE STANDING MAGNIFYING MIRROR (X5)
ESPEJO AUMENTO ENCIMERA (X5)

- WJP077A8101001
- MATTE WHITE-CHROME / BLANCO MATE-CROMO
- WJP077A8101004
- MATTE WHITE-GOLD/ BLANCO MATE-ORO
- WJP077A8101007
- MATTE WHITE-BRONZE / BLANCO MATE-BRONCE

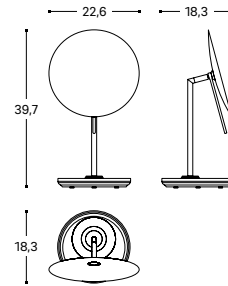

INCH 1.7x1.6x1.7



TOWEL RACK
TOALLERO

- WJP077A1030001
- MATTE WHITE-CHROME / BLANCO MATE-CROMO
- WJP077A1030004
- MATTE WHITE-GOLD/ BLANCO MATE-ORO
- WJP077A1030007
- MATTE WHITE-BRONZE / BLANCO MATE-BRONCE

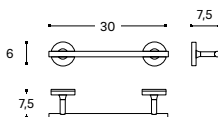

INCH 11.8x3x2.4



TOWEL RACK
TOALLERO

- WJP077A1040001
- MATTE WHITE-CHROME / BLANCO MATE-CROMO
- WJP077A1040004
- MATTE WHITE-GOLD/ BLANCO MATE-ORO
- WJP077A1040007
- MATTE WHITE-BRONZE / BLANCO MATE-BRONCE

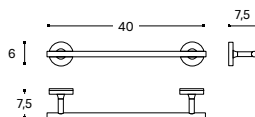

INCH 15.8x3x2.4



TOWEL RACK
TOALLERO

- WJP077A1060001
- MATTE WHITE-CHROME / BLANCO MATE-CROMO
- WJP077A1060004
- MATTE WHITE-GOLD/ BLANCO MATE-ORO
- WJP077A1060007
- MATTE WHITE-BRONZE / BLANCO MATE-BRONCE

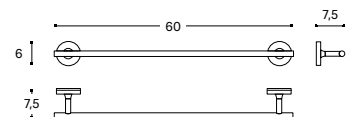

INCH 23.6x3x2.4

● HEXAGON MATTE WHITE
● HEXÁGONO BLANCO MATE
● RIBS MATTE WHITE
● RAYAS BLANCO MATE

● NETTING BRIGHT WHITE
● NETTING BLANCO BRILLO
● CIRCLES BRIGHT WHITE
● CIRCLOS BLANCO BRILLO

Equilibrium

Design by Edward van Vliet



DOUBLE TOWEL RACK
TOALLERO DOBLE

- WJP077A1442001**
MATTE WHITE-CHROME / BLANCO MATE-CROMO
- WJP077A1442004**
MATTE WHITE-GOLD / BLANCO MATE-ORO
- WJP077A1442007**
MATTE WHITE-BRONZE / BLANCO MATE-BRONCE

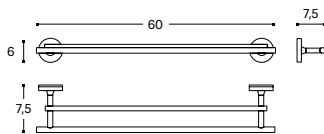

INCH 23.6x4.7x2.4



TOWEL RING
TOALLERO ARO

- WJP077A2005001**
MATTE WHITE-CHROME / BLANCO MATE-CROMO
- WJP077A2005004**
MATTE WHITE-GOLD / BLANCO MATE-ORO
- WJP077A2005007**
MATTE WHITE-BRONZE / BLANCO MATE-BRONCE

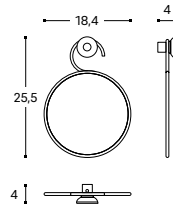

INCH 7.2x1.6x10



PAPER HOLDER WITH COVER
PORTAPAPEL CON TAPA

- WJP077A4002001**
MATTE WHITE-CHROME / BLANCO MATE-CROMO
- WJP077A4002004**
MATTE WHITE-GOLD / BLANCO MATE-ORO
- WJP077A4002007**
MATTE WHITE-BRONZE / BLANCO MATE-BRONCE

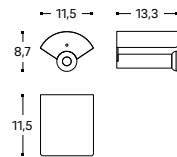

INCH 4.5x5.2x3.4



TUMBLER
VASO

- WJP077A7506500**
- WJP077A7508500**
WHITE / BLANCO
- WJP077A7506540**
- WJP077A7508540**
CELADON / CELADON
- WJP077A7505501**
- WJP077A7507501**
WHITE-PLATINUM / BLANCO-PLATINO
- WJP077A7505504**
- WJP077A7507504**
WHITE-GOLD / BLANCO-ORO

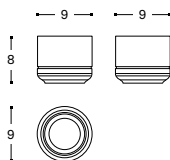

INCH 4.5x5.2x3.4



POT
FRASCO

- WJP077A7515501**
- WJP077A7517501**
WHITE-CHROME / BLANCO-CROMO
- WJP077A7515504**
- WJP077A7517504**
WHITE-GOLD / BLANCO-ORO
- WJP077A7515507**
- WJP077A7517507**
WHITE-BRONZE / BLANCO-BRONCE

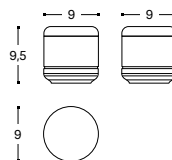

INCH 6.7x3x2.4



WASTE BIN
PAPELERA

- WJP077A9355501**
- WJP077A9357501**
- WJP077A9358501**
WHITE-CHROME / BLANCO-CROMO
- WJP077A9355504**
- WJP077A9357504**
- WJP077A9358504**
WHITE-GOLD / BLANCO-ORO
- WJP077A9355507**
- WJP077A9357507**
- WJP077A9358507**
WHITE-BRONZE / BLANCO-BRONCE

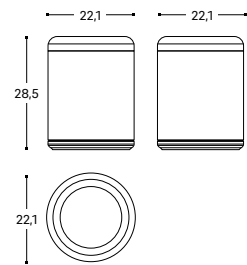

INCH 8.6x8.6x11.2



FREE STANDING TOILET BRUSH
ESCOBILLERO SUELO

- ⊗ **WJP077A9055501**
- ⊗ **WJP077A9056501**
- ⊗ **WJP077A9057501**
- ⊗ **WJP077A9058501**
WHITE-CHROME / BLANCO-CROMO
- ⊗ **WJP077A9055504**
- ⊗ **WJP077A9056504**
- ⊗ **WJP077A9057504**
- ⊗ **WJP077A9058504**
WHITE-GOLD / BLANCO-ORO
- ⊗ **WJP077A9055507**
- ⊗ **WJP077A9056507**
- ⊗ **WJP077A9057507**
- ⊗ **WJP077A9058507**
WHITE-BRONZE / BLANCO-BRONCE

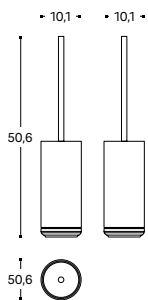

INCH 11.8x3x2.4



FREE STANDING TOILET BRUSH/PAPER HOLDER
ESCOBILLERO SUELO/PORTAPEL

- ⊗ **WJP077A1905501**
- ⊗ **WJP077A1906501**
- ⊗ **WJP077A1907501**
- ⊗ **WJP077A1908501**
WHITE-CHROME / BLANCO-CROMO
- ⊗ **WJP077A1905504**
- ⊗ **WJP077A1906504**
- ⊗ **WJP077A1907504**
- ⊗ **WJP077A1908504**
WHITE-GOLD / BLANCO-ORO
- ⊗ **WJP077A1905507**
- ⊗ **WJP077A1906507**
- ⊗ **WJP077A1907507**
- ⊗ **WJP077A1908507**
WHITE-BRONZE / BLANCO-BRONCE

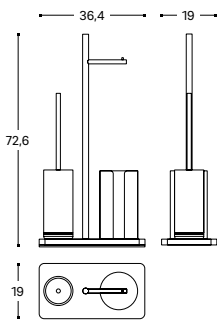

INCH 23.6x4.7x2.4

- ⊗ HEXAGON MATTE WHITE
HEXÁGONO BLANCO MATE
- ⊗ RIBS MATTE WHITE
RAYAS BLANCO MATE

- ⊗ NETTING BRIGHT WHITE
NETTING BLANCO BRILLO
- ⊗ CIRCLES BRIGHT WHITE
CIRCLOS BLANCO BRILLO



HOOK
COLGADOR

WJP077L5502520
RIBS MATTE WHITE-GLOSSY WHITE /
RAYAS BLANCO MATE-BLANCO BRILLO

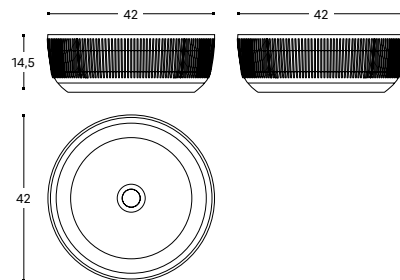

INCH 16.5x16.5x5.7



RIGHT PAPER HOLDER WITHOUT COVER
PORTAPEL SIN TAPA DERECHO

- WJP077A4001001**
MATTE WHITE-CHROME / BLANCO MATE-CROMO
- WJP077A4001004**
MATTE WHITE-GOLD/ BLANCO MATE-ORO
- WJP077A4001007**
MATTE WHITE-BRONZE / BLANCO MATE-BRONCE

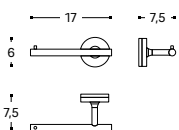

INCH 6.7x3x2.4



LEFT PAPER HOLDER WITHOUT COVER
PORTAPEL SIN TAPA IZQUIERDO

- WJP077A4010001**
MATTE WHITE-CHROME / BLANCO MATE-CROMO
- WJP077A4010004**
MATTE WHITE-GOLD/ BLANCO MATE-ORO
- WJP077A4010007**
MATTE WHITE-BRONZE / BLANCO MATE-BRONCE

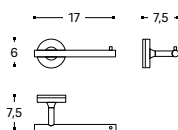

INCH 6.7x3x2.4



VERTICAL PAPER HOLDER
PORTAPEL VERTICAL

- WJP077A4042001**
MATTE WHITE-CHROME / BLANCO MATE-CROMO
- WJP077A4042004**
MATTE WHITE-GOLD/ BLANCO MATE-ORO
- WJP077A4042007**
MATTE WHITE-BRONZE / BLANCO MATE-BRONCE

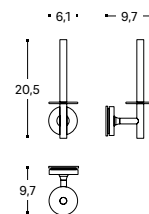

INCH 16.5x16.5x5.7

Extreme

Design by **Cosmic Studio**







Serene balance between sober elegance of rectangular lines and the sensuality released by its smooth curves.

Sereno equilibrio entre la sobria elegancia de las líneas rectangulares y la sensualidad que desprenden sus suaves curvas.









10
YEARS GUARANTEE
AÑOS GARANTÍA
—
COSMIC

Extreme has successfully passed the high demanding tests of long last durability and resistance to extreme uses (static charge or impact testing) to assure long last durability of the product.

Toda la gama **Extreme** ha superado con éxito exigentes tests de durabilidad y resistencia a usos extremos (cargas estáticas o test de impacto), para asegurar una larga vida al producto.



FEATURES / CARACTERÍSTICAS

Easy installation: double pitch screw.
Hidden attachments. Anti-corrosion.
Tempered glass shelf (high safety).

Fácil instalación: tornillo de doble paso.
Fijaciones ocultas. Anticorrosión.
Estante de vidrio templado (alta seguridad).

FINISHES / ACABADOS

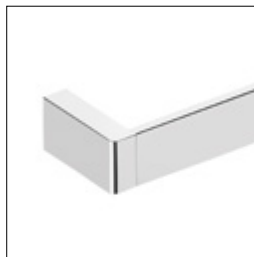

001
Chrome
Cromo



061
Chrome - black
Cromo - negro



⊙
HOOK
COLGADOR

WJC253A0021001

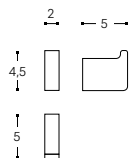

INCH 0.8x2x1.8



⊙
SOAP DISH
JABONERA

WJC253A0032001

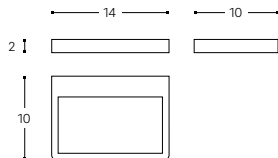

INCH 5.5x3.9x0.8



⊙△
FREE STANDING BRUSH-HOLDER
PORTACEPILLOS ENCIMERA

WJC253A0053001

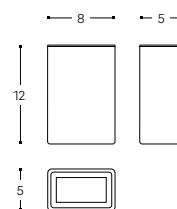

INCH 3.1x2x4.7



⊙△
BRUSH-HOLDER
PORTACEPILLOS

WJC253A0052001

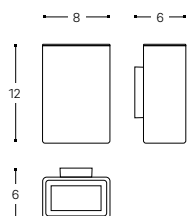

INCH 3.1x2.4x4.7



⊙△
FREE STANDING SOAP DISPENSER
DOSIFICADOR ENCIMERA

WJC253A0004001
225 ML

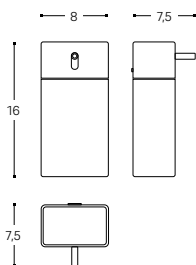

INCH 3.1x2.9x6.3



⊙△
SOAP DISPENSER
DOSIFICADOR

WJC253A0005001

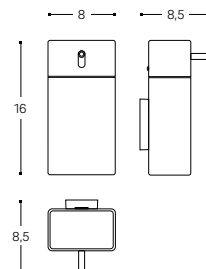

INCH 3.1x3.3x6.3





◆◆
SHELF
ESTANTE

WJC253A0044001
40 CM / INCH 15.7

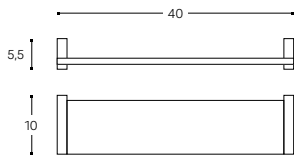

INCH 15.7x3.9x2.2

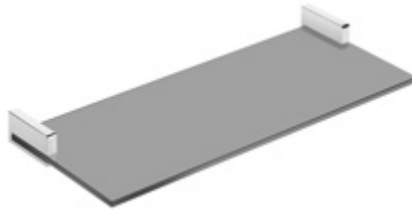

◆◆
TOWEL RACK SHELF
TOALLERO ESTANTE

WJC253A0068001

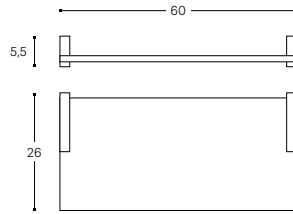

INCH 23.6x3.9x2.2



◆△
SOAP WIRE BASKET *
JABONERA DE DUCHA *

WJC251A0049061

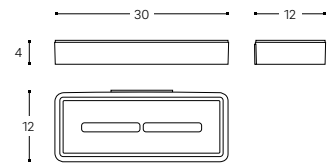

INCH 11.8x4.7x1.6

* CAN BE TAKEN APART FOR CLEANING.
* EXTRAIBLES PARA SU LIMPIEZA.



◆△
CORNER SHOWER WIRE BASKET *
JABONERA DE DUCHA RINCÓN *

WJC251A0050061

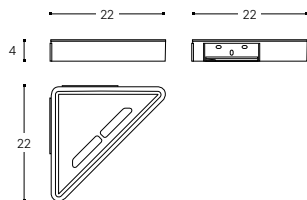

INCH 8.7x8.7x1.6



◆
TOWEL RACK
TOALLERO

WJC253A0063001
30 CM / INCH 11.8
WJC253A0064001
45 CM / INCH 17.7
WJC253A0065001
60 CM / INCH 23.6
WJC253A0066001
80 CM / INCH 31.5

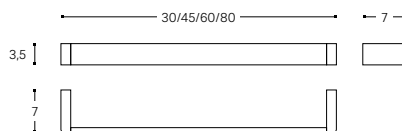

INCH 11.8/17.7/23.6/31.5x2.7x1.4



◆
SWIVEL DOUBLE TOWEL RACK
TOALLERO DOBLE GIRATORIO

WJC253A0075001

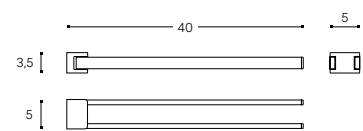

INCH 15.7x2x1.4

* CAN BE TAKEN APART FOR CLEANING.
* EXTRAIBLES PARA SU LIMPIEZA.





TOWEL RING
TOALLERO ARO

WJC253A0071001

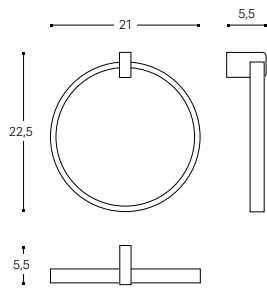

INCH 8.3x2.2x8.8



PAPER HOLDER WITH COVER
PORTAPAPEL CON TAPA

WJC251A0059001

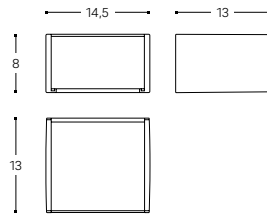

INCH 5.7x5.1x3.1



PAPER HOLDER WITHOUT COVER
PORTAPAPEL SIN TAPA

WJC253A0058001

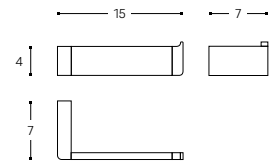

INCH 5.9x2.7x1.6



FLOOR TOILET BRUSH
ESCOBILLERO SUELO

WJC253A0001001

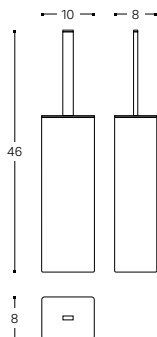

INCH 3.9x3.1x18.1



TOILET BRUSH
ESCOBILLERO

WJC253A0000001

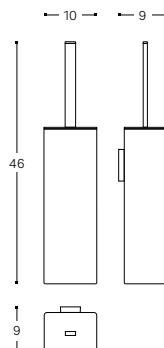

INCH 3.9x3.5x18.1



Kubic

Design by **Cosmic Studio**









Objects that reveal secrets and raise the ritual bath to the world of illusion. Their reflections become the best ally.

Objetos que revelan secretos y elevan el ritual del baño al mundo de la ilusión. Sus reflejos se convierten en el mejor aliado.









DUAL SYSTEM / SISTEMA DUAL

Our updated Kubic collection now includes a dual installation system for installing bathroom accessories with or without a drill. Smart-fix adhesive, designed exclusively for our firm, means that bathroom accessories can be installed without drilling holes in the wall.

La colección Kubic presenta como novedad el sistema de instalación dual, que permite sujetar los accesorios de baño con y sin taladros. Con el adhesivo Smart-fix, elaborado en exclusiva para la firma, se facilita el montaje sin la necesidad de hacer agujeros en la pared.

FEATURES / CARACTERÍSTICAS

Easy installation: double pitch screw.
Hidden attachments. Anti-corrosion.

Fácil instalación: tornillo de doble paso.
Fijaciones ocultas. Anticorrosión.

BLACK EDITION / BLACK EDITION

Cosmic brings to light a new and totally innovative finish in the bathroom sector. Black Edition is an extra-matt black finish, the result of a process widely used in the automotive sector, electrophoresis. This process provides a high resistance to scratches, uniformity in the finish and a soft and pleasant texture to the touch.

This option not only allows you to give your bathroom an elegant and trendy style, but also ensures excellent quality in each piece.

Cosmic saca a la luz un nuevo acabado totalmente innovador en el sector del baño. Black Edition es un acabado negro extra-mate, resultado de un proceso muy utilizado en el sector automovilístico, la electroforesis. Este proceso aporta una gran resistencia a las rayaduras, uniformidad en el acabado y una textura suave y agradable al tacto.

Esta opción no solo te permite darle al baño un estilo elegante y en tendencia, si no que te asegura una excelente calidad en cada pieza.

Kubic has successfully passed the high demanding tests of long last durability and resistance to extreme uses (static charge or impact testing) to assure long last durability of the product. All products come with 10 years warranty, except for waste bins and stools, which come with 3 years warranty.

Toda la gama Kubic ha superado con éxito exigentes tests de durabilidad y resistencia a usos extremos (cargas estáticas o test de impacto), para asegurar una larga vida al producto. Todos los artículos tienen 10 años de garantía a excepción de las papeleras y los taburetes que tienen una garantía de 3 años.

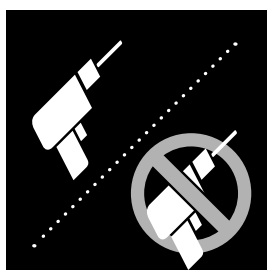

**SMART
FIX**

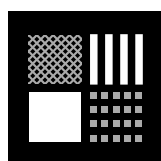

Works with different surfaces*

Efectivo en diferentes superficies*



Static load of 15 kg

Carga estática de 15 KG

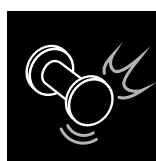

Impact resistance

Resistente a impactos



Removable accessories

Accesorios removibles



Quick, easy, silent installation

Montaje sin ruido, fácil y rápido

* Ceramic, porcelain, glazed surfaces, compact marble, even surfaces with roughness up to 0.5 mm thickness.

* Cerámica, porcelana, materiales vitrificados o mármoles compactos, e incluso superficies con una rugosidad de hasta 0,5 milímetros de espesor.





⊙
HOOK
COLGADOR

- S** **WJP036A3011001**
CHROME / CROMO
- WJP036A3011036**
BLACK / NEGRO

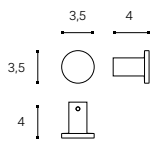

INCH 1.4x1.6x1.4



⊙
HOOK
COLGADOR

- D** **WJP036D3011001**
2U. DUAL CHROME / CROMO DUAL
- D** **WJP036D3011036**
2U. DUAL BLACK / NEGRO DUAL

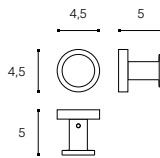

INCH 1.8x2x1.8



⊙
HOOK
COLGADOR

- S** **WJP036A3001001**
CHROME / CROMO
- WJP036A3001036**
BLACK / NEGRO

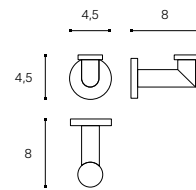

INCH 1.8x3.1x1.8



⊙
HOOK
COLGADOR

- D** **WJP036D3001001**
2U. DUAL CHROME / CROMO DUAL
- D** **WJP036D3001036**
2U. DUAL BLACK / NEGRO DUAL

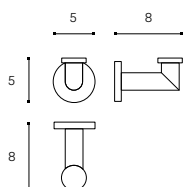

INCH 3.8x3.3x15.5



⊙
DOUBLE HOOK
COLGADOR DOBLE

- D** **WJP036A3002001**
CHROME / CROMO
- D** **WJP036D3002001**
DUAL CHROME / CROMO DUAL

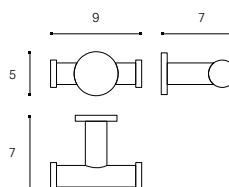

INCH 4.9x3.3x16.9



⊙
TOWEL RACK
TOALLERO

- D** **WJP036A1060001**
60 CM CHROME / CROMO
- D** **WJP036D1060001**
60 CM DUAL CHROME / CROMO DUAL
- WJP036A1060036**
60 CM BLACK / NEGRO
- D** **WJP036D1060036**
60 CM DUAL BLACK / NEGRO DUAL

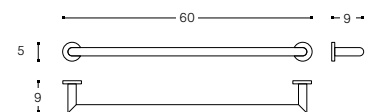

INCH 3.8x2.6x15.5





TOWEL RACK
TOALLERO

- WJP036A1050001**
50 CM CHROME / CROMO
- D WJP036D1050001**
50 CM DUAL CHROME / CROMO DUAL

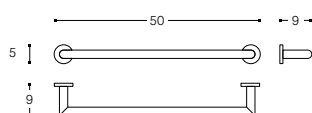

INCH 19.7x3.5x2



TOWEL RACK
TOALLERO

- S WJP036A1040001**
40 CM CHROME / CROMO
- D WJP036D1040001**
40 CM DUAL CHROME / CROMO DUAL
- WJP036A1040036**
40 CM BLACK / NEGRO
- D WJP036D1040036**
40 CM DUAL BLACK / NEGRO DUAL

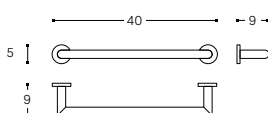

INCH 15.7x3.5x2



TOWEL RACK
TOALLERO

- WJP036A1030001**
30 CM CHROME / CROMO
- D WJP036D1030001**
30 CM DUAL CHROME / CROMO DUAL
- WJP036A1030036**
30 CM BLACK / NEGRO
- D WJP036D1030036**
30 CM DUAL BLACK / NEGRO DUAL

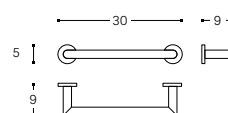

INCH 11.8x3.5x2



DOUBLE TOWEL RACK
TOALLERO DOBLE

- WJP036A1442001**
CHROME / CROMO
- D WJP036D1442001**
DUAL CHROME / CROMO DUAL

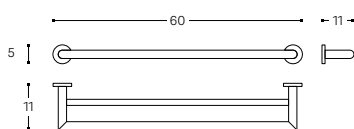

INCH 23.6x4.3x2



TOWEL RING
TOALLERO ARO

- WJP036A2055001**
CHROME / CROMO
- D WJP036D2055001**
DUAL CHROME / CROMO DUAL

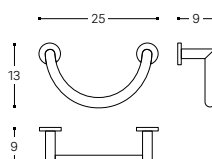

INCH 9.8x3.5x5.1



TOWEL RING
TOALLERO ARO

- WJP036A2057001**
CHROME / CROMO
- D WJP036D2057001**
DUAL CHROME / CROMO DUAL
- WJP036A2057036**
BLACK / NEGRO
- D WJP036D2057036**
DUAL BLACK / NEGRO DUAL

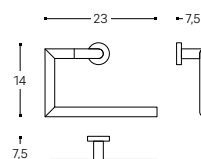

INCH 9.1x2.8x5.5



DOUBLE LATERAL TOWEL RACK
TOALLERO LATERAL DOBLE

WJP036A1401001
CHROME / CROMO

D WJP036D1401001
DUAL CHROME / CROMO DUAL

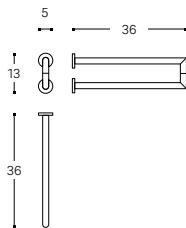

INCH 2x14.2x5.1



TOWEL RACK SHELF
TOALLERO ESTANTE

WJP036A5110001
CHROME / CROMO

D WJP036D5110001
DUAL CHROME / CROMO DUAL

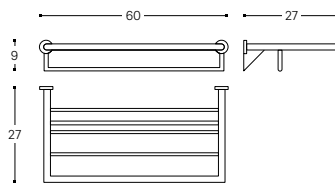

INCH 23.6x10.6x3.5



FREE STANDING TOWEL RACK
TOALLERO DE PIE

WJP036A1204001
CHROME / CROMO

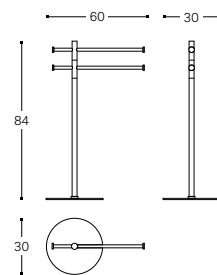

INCH 15x11.8x33.1



FREE STANDING HANGER
COLGADOR DE PIE

WJP036A3102001
CHROME / CROMO

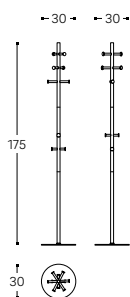

INCH 11.8x11.8x68.9



GLASS SHELF
ESTANTE VIDRIO

WJP036A5060001
60 CM CHROME / CROMO

D WJP036D5060001
60 CM DUAL CHROME / CROMO DUAL

WJP036A5040001
40 CM CHROME / CROMO

D WJP036D5040001
40 CM DUAL CHROME / CROMO DUAL

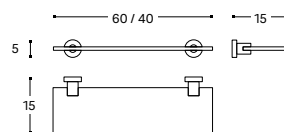

INCH 23.6/15.7x5.9x2



SOAP WIRE BASKET
JABONERA DE DUCHA

WJP036A6020001
60 CM CHROME / CROMO

D WJP036D6020001
60 CM DUAL CHROME / CROMO DUAL

WJP036A6020036
60 CM BLACK / NEGRO

D WJP036D6020036
60 CM DUAL BLACK / NEGRO DUAL

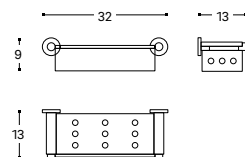

INCH 3.8x2.6x15.5





○
CORNER SHOWER WIRE BASKET
JABONERA DE DUCHA RINCÓN

WJP036A6032001
CHROME / CROMO

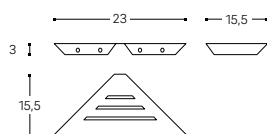

INCH 9.1x9.1x1.2



⊙
GRAB BAR
ASA BAÑERA

WJP036A0536001
CHROME / CROMO

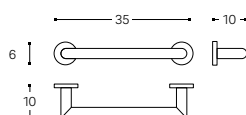

INCH 13.8x3.9x2.4



⊙
GRAB BAR
ASA BAÑERA

WJP036A0535001
CHROME / CROMO

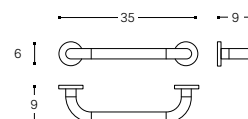

INCH 13.8x3.5x2.4



⊙
GRAB BAR
ASA BAÑERA

WJP036A0550001
CHROME / CROMO

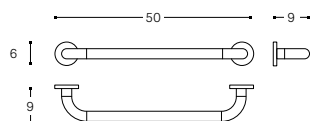

INCH 19.7x3.5x2.4



⊙
GRAB BAR
ASA BAÑERA

WJP036A0565001
CHROME / CROMO

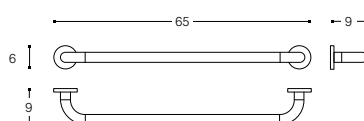

INCH 25.6x3.5x2.4



⊙
PAPER HOLDER WITHOUT COVER
PORTAPAPEL SIN TAPA

S WJP036A1481001
CHROME / CROMO

D WJP036D1481001
DUAL CHROME / CROMO DUAL

WJP036A1481036
BLACK / NEGRO

D WJP036D1481036
DUAL BLACK / NEGRO DUAL

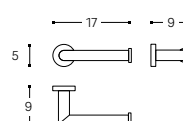

INCH 6.7x3.5x2



RIGHT PAPER HOLDER WITH COVER
PORTAPAPEL CON TAPA DERECHO

- S** **WJP036A4005001**
CHROME / CROMO
- D** **WJP036D4005001**
DUAL CHROME / CROMO DUAL
- WJP036A4005036**
BLACK / NEGRO
- D** **WJP036D4005036**
DUAL BLACK / NEGRO DUAL

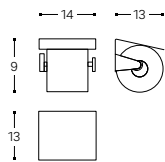

INCH 5.5x5.1x3.5



PAPER HOLDER WITH COVER
PORTAPAPEL CON TAPA

- S** **WJP036A4012001**
CHROME / CROMO
- D** **WJP036D4012001**
DUAL CHROME / CROMO DUAL

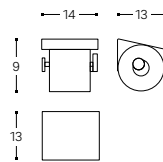

INCH 5.5x5.1x3.5



VERTICAL PAPER HOLDER
PORTAPAPEL VERTICAL

- S** **WJP036A4042001**
CHROME / CROMO
- D** **WJP036D4042001**
DUAL CHROME / CROMO DUAL
- WJP036A4042036**
BLACK / NEGRO
- D** **WJP036D4042036**
DUAL BLACK / NEGRO DUAL

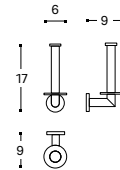

INCH 2.4x3.5x6.7



TOILET BRUSH
ESCOBILLERO

- S** **WJP036A9002001**
CHROME / CROMO
- D** **WJP036D9002001**
DUAL CHROME / CROMO DUAL
- WJP036A9002036**
BLACK / NEGRO
- D** **WJP036D9002036**
DUAL BLACK / NEGRO DUAL

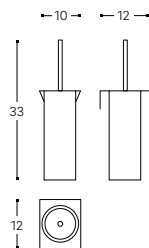

INCH 3.9x4.7x13



FREE STANDING TOILET BRUSH
ESCOBILLERO SUELO

- S** **WJP036A9051001**
CHROME / CROMO
- WJP036A9051036**
BLACK / NEGRO

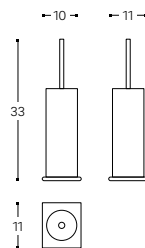

INCH 3.9x4.3x13



FREE STANDING TOILET BRUSH/PAPER HOLDER
ESCOBILLERO/PORTAPAPEL SUELO

- S** **WJP036A1904001**
CHROME / CROMO

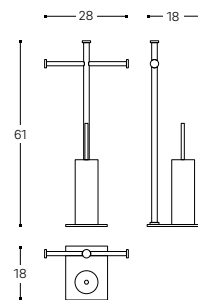

INCH 11x7.1x24





BRUSH-HOLDER
PORTACEPILLOS

WJP036A7002001
CHROME / CROMO

D **WJP036D7002001**
DUAL CHROME / CROMO DUAL

WJP036A7002036
BLACK / NEGRO

D **WJP036D7002036**
DUAL BLACK / NEGRO DUAL

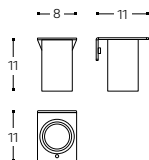

INCH 3.1x4.3x4.3



SOAP DISPENSER
DOSIFICADOR

WJP036A7805001
CHROME / CROMO

D **WJP036D7805001**
125 ML DUAL CHROME / CROMO DUAL

WJP036A7805036
BLACK / NEGRO

D **WJP036D7805036**
125 ML DUAL BLACK / NEGRO DUAL

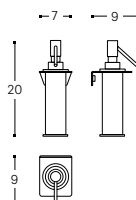

INCH 2.8x3.5x7.9



SOAP DISH
JABONERA

WJP036A6003001
CHROME / CROMO

D **WJP036D6003001**
DUAL CHROME / CROMO DUAL

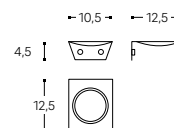

INCH 4.1x4.9x1.8



FREE STANDING BRUSH-HOLDER
PORTACEPILLOS ENCIMERA

WJP036A7050001
CHROME / CROMO

WJP036A7050036
BLACK / NEGRO

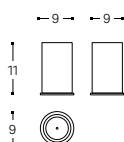

INCH 3.5x3.5x4.3



FREE STANDING SOAP DISPENSER
DOSIFICADOR ENCIMERA

WJP036A7832001
250 ML CHROME / CROMO

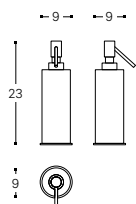

INCH 3.5x3.5x9.1



FREE STANDING SOAP DISPENSER
DOSIFICADOR ENCIMERA

WJP036A7831001
125 ML CHROME / CROMO

WJP036A7831036
125 ML BLACK / NEGRO

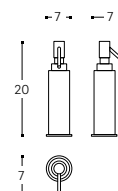

INCH 2.8x2.8x7.9



TISSUE BOX
CAJA KLEENEX

WJP036A9402001
CHROME / CROMO

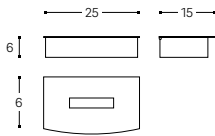

INCH 9.8x5.9x2.4



WASTE BIN
PAPELERA

WJP036A9351001
CHROME / CROMO

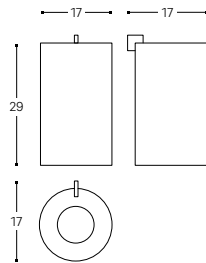

INCH 6.7x11.4



SHOWER SEAT
ASIENTO DUCHA

90 KG RESISTANCE. / RESISTENCIA HASTA 90 KG.

WJP033A9230001
CHROME / CROMO

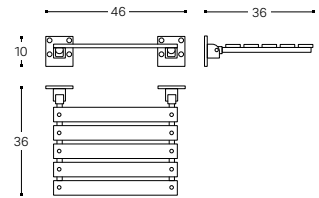

INCH 18.1x14.2x3.9





Kubic Class

Design by **Cosmic Studio**









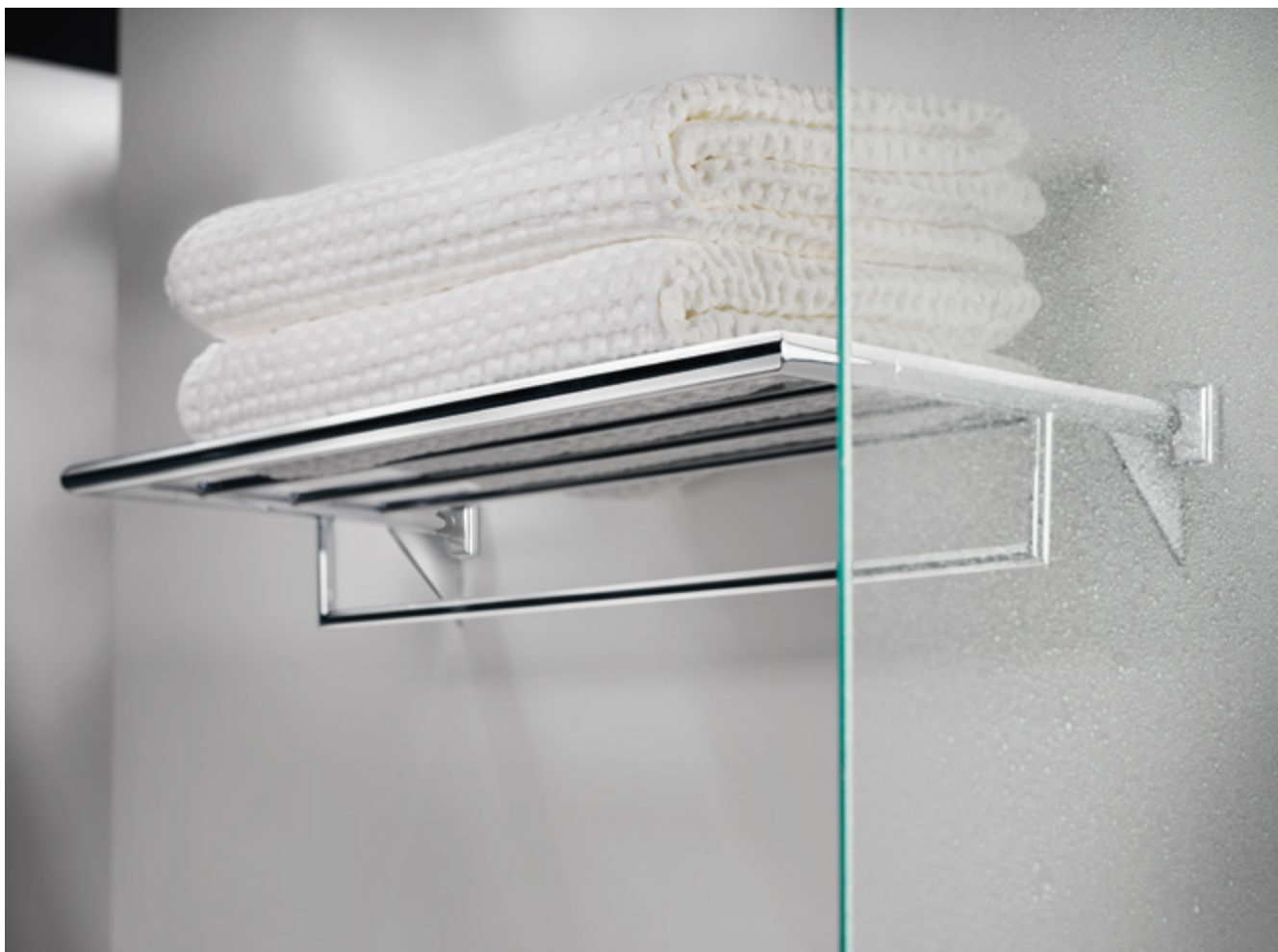

Sensuality and perfection that, combined with its smoothly formed elements, accentuate its most exclusive style.

Sensualidad y perfección que combinadas con elementos de suaves formas resaltan el estilo más exclusivo.





Kubic Class

Design by Cosmic Studio





DUAL SYSTEM / SISTEMA DUAL

Our updated Kubic Class collection now includes a dual installation system for installing bathroom accessories with or without a drill. Smart-fix adhesive, designed exclusively for our firm, means that bathroom accessories can be installed without drilling holes in the wall.

La colección Kubic Class presenta como novedad el sistema de instalación dual, que permite sujetar los accesorios de baño con y sin taladros. Con el adhesivo Smart-fix, elaborado en exclusiva para la firma, se facilita el montaje sin la necesidad de hacer agujeros en la pared.

FEATURES / CARACTERÍSTICAS

Easy installation: double pitch screw.
Hidden attachments. Anti-corrosion.

Fácil instalación: tornillo de doble paso.
Fijaciones ocultas. Anticorrosión.



BLACK EDITION / BLACK EDITION

Cosmic brings to light a new and totally innovative finish in the bathroom sector. Black Edition is an extra-matt black finish, the result of a process widely used in the automotive sector, electrophoresis. This process provides a high resistance to scratches, uniformity in the finish and a soft and pleasant texture to the touch.

This option not only allows you to give your bathroom an elegant and trendy style, but also ensures excellent quality in each piece.

Cosmic saca a la luz un nuevo acabado totalmente innovador en el sector del baño. Black Edition es un acabado negro extra-mate, resultado de un proceso muy utilizado en el sector automovilístico, la electroforesis. Este proceso aporta una gran resistencia a las rayaduras, uniformidad en el acabado y una textura suave y agradable al tacto.

Esta opción no solo te permite darle al baño un estilo elegante y en tendencia, si no que te asegura una excelente calidad en cada pieza.



Kubic Class has successfully passed the high demanding tests of long last durability and resistance to extreme uses (static charge or impact testing) to assure long last durability of the product. All products come with 10 years warranty, except for waste bins and stools, which come with 3 years warranty.

Toda la gama **Kubic Class** ha superado con éxito exigentes tests de durabilidad y resistencia a usos extremos (cargas estáticas o test de impacto), para asegurar una larga vida al producto. Todos los artículos tienen 10 años de garantía a excepción de las papeleras y los taburetes que tienen una garantía de 3 años.

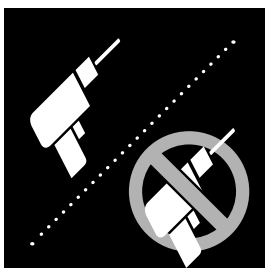

**SMART
FIX**

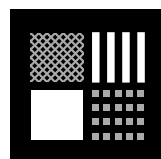

Works with different surfaces*

Efectivo en diferentes superficies*



Static load of 15 kg

Carga estática de 15 KG



Impact resistance

Resistente a impactos



Removable accessories

Accesorios removibles



Quick, easy, silent installation

Montaje sin ruido, fácil y rápido

* Ceramic, porcelain, glazed surfaces, compact marble, even surfaces with roughness up to 0.5 mm thickness.

* Cerámica, porcelana, materiales vitrificados o mármoles compactos, e incluso superficies con una rugosidad de hasta 0,5 milímetros de espesor.

Kubic Class

Design by **Cosmic Studio**

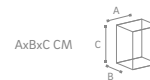

⊙
HOOK
COLGADOR

- S** **WJP043A3011001**
CHROME / CROMO
- WJP043A3011036**
BLACK / NEGRO



INCH 1.4x1.4x1.4



⊙
HOOK
COLGADOR

- D** **WJP043D3011001**
2U. DUAL CHROME / CROMO DUAL
- D** **WJP043D3011036**
2U. DUAL BLACK / NEGRO DUAL

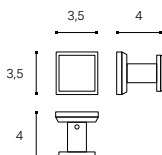

INCH 1.4x1.6x1.4



⊙
HOOK
COLGADOR

- S** **WJP043A3001001**
CHROME / CROMO
- WJP043A3001036**
BLACK / NEGRO

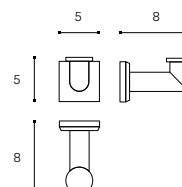

INCH 2x3.1x2



⊙
HOOK
COLGADOR

- D** **WJP043D3001001**
2U. DUAL CHROME / CROMO DUAL
- D** **WJP043D3001036**
2U. DUAL BLACK / NEGRO DUAL

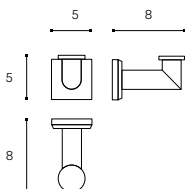

INCH 2x3.1x2



⊙
DOUBLE HOOK
COLGADOR DOBLE

- D** **WJP043A3002001**
CHROME / CROMO
- D** **WJP043D3002001**
DUAL CHROME / CROMO DUAL

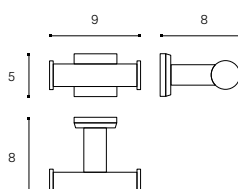

INCH 3.5x3.1x2



⊙
TOWEL RACK
TOALLERO

- D** **WJP043A1060001**
60 CM CHROME / CROMO
- D** **WJP043D1060001**
60 CM DUAL CHROME / CROMO DUAL
- WJP043A1060036**
60 CM BLACK / NEGRO
- D** **WJP043D1060036**
60 CM DUAL BLACK / NEGRO DUAL

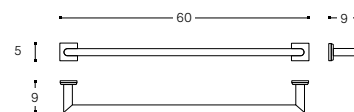

INCH 23.6x3.5x1.6





TOWEL RACK
TOALLERO

- S **WJP043A1050001**
50 CM CHROME / CROMO
- D **WJP043D1050001**
50 CM DUAL CHROME / CROMO DUAL

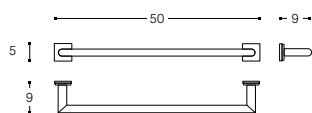

INCH 19.7x3.5x2



TOWEL RACK
TOALLERO

- WJP043A1040001**
40 CM CHROME / CROMO
- D **WJP043D1040001**
40 CM DUAL CHROME / CROMO DUAL
- WJP043A1040036**
40 CM BLACK / NEGRO
- D **WJP043D1040036**
40 CM DUAL BLACK / NEGRO DUAL

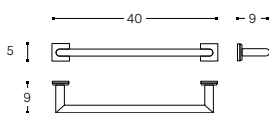

INCH 15.7x3.5x2



TOWEL RACK
TOALLERO

- WJP043A1030001**
30 CM CHROME / CROMO
- D **WJP043D1030001**
30 CM DUAL CHROME / CROMO DUAL
- WJP043A1030036**
30 CM BLACK / NEGRO
- D **WJP043D1030036**
30 CM DUAL BLACK / NEGRO DUAL

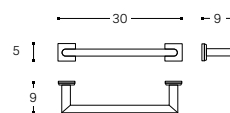

INCH 11.8x3.5x2



DOUBLE TOWEL RACK
TOALLERO DOBLE

- WJP043A1442001**
CHROME / CROMO
- D **WJP043D1442001**
DUAL CHROME / CROMO DUAL

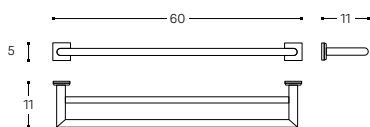

INCH 23.6x4.3x2



TOWEL RING
TOALLERO ARO

- WJP043A2055001**
CHROME / CROMO
- D **WJP043D2055001**
DUAL CHROME / CROMO DUAL

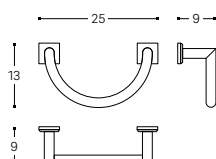

INCH 9.8x3.5x5.1



TOWEL RING
TOALLERO ARO

- WJP043A2057001**
CHROME / CROMO
- D **WJP043D2057001**
DUAL CHROME / CROMO DUAL
- WJP043A2057036**
BLACK / NEGRO
- D **WJP043D2057036**
DUAL BLACK / NEGRO DUAL

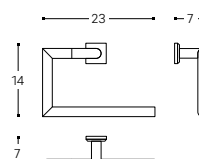

INCH 9.1x2.8x5.5

Kubic Class

Design by **Cosmic Studio**

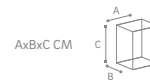

DOUBLE LATERAL TOWEL RACK
TOALLERO LATERAL DOBLE

WJP043A1401001
CHROME / CROMO

D WJP043D1401001
DUAL CHROME / CROMO DUAL

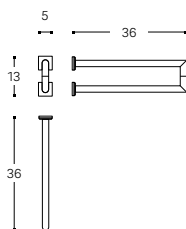

INCH 2x14.2x5.1



TOWEL RACK SHELF
TOALLERO ESTANTE

WJP043A5110001
CHROME / CROMO

D WJP043D5110001
DUAL CHROME / CROMO DUAL

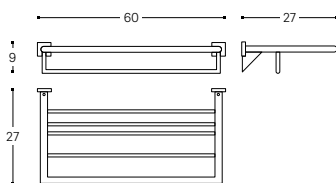

INCH 23.6x10.6x3.5



FREE STANDING TOWEL RACK
TOALLERO DE PIE

WJP036A1204001
CHROME / CROMO

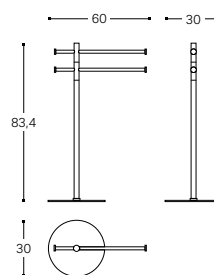

INCH 15x11.8x33.1



FREE STANDING HANGER
COLGADOR DE PIE

WJP036A3102001
CHROME / CROMO

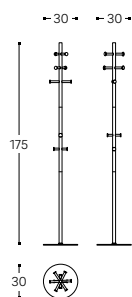

INCH 11.8x11.8x68.9



GLASS SHELF
ESTANTE VIDRIO

WJP043A5060001
60 CM CHROME / CROMO

D WJP043D5060001
60 CM DUAL CHROME / CROMO DUAL

WJP043A5040001
40 CM CHROME / CROMO

D WJP043D5040001
40 CM DUAL CHROME / CROMO DUAL

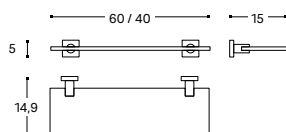

INCH 23.6/15.7x5.9x2



SOAP WIRE BASKET
JABONERA DE DUCHA

WJP043A6020001
60 CM CHROME / CROMO

D WJP043D6020001
60 CM DUAL CHROME / CROMO DUAL

WJP043A6020036
60 CM BLACK / NEGRO

D WJP043D6020036
60 CM DUAL BLACK / NEGRO DUAL

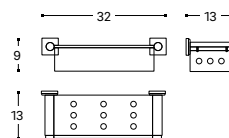

INCH 3.8x2.6x15.5





○
CORNER SHOWER WIRE BASKET
JABONERA DE DUCHA RINCÓN

WJP036A6032001
CHROME / CROMO

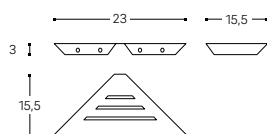

INCH 9.1x6.1x1.2



⊙
GRAB BAR
ASA BAÑERA

WJP036A0536001
CHROME / CROMO

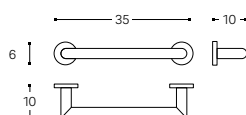

INCH 13.8x3.9x2.4



⊙
GRAB BAR
ASA BAÑERA

WJP036A0535001
CHROME / CROMO

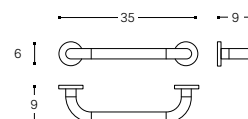

INCH 13.8x3.5x2.4



⊙
GRAB BAR
ASA BAÑERA

WJP036A0550001
CHROME / CROMO

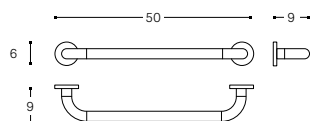

INCH 19.7x3.5x2.4



⊙
GRAB BAR
ASA BAÑERA

WJP036A0565001
CHROME / CROMO

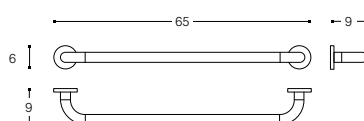

INCH 25.6x3.5x2.4



⊙
PAPER HOLDER WITHOUT COVER
PORTAPAPEL SIN TAPA

S **WJP043A1481001**
CHROME / CROMO

D **WJP043D1481001**
DUAL CHROME / CROMO DUAL

WJP043A14810036
BLACK / NEGRO

D **WJP043D1481036**
DUAL BLACK / NEGRO DUAL

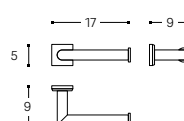

INCH 6.7x3.5x2

Kubic Class

Design by Cosmic Studio

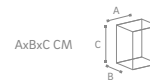

RIGHT PAPER HOLDER WITH COVER
PORTAPAPEL CON TAPA DERECHO

- S** **WJP036A4005001**
CHROME / CROMO
- D** **WJP036D4005001**
DUAL CHROME / CROMO DUAL
- WJP036A4005036**
BLACK / NEGRO
- D** **WJP036D4005036**
DUAL BLACK / NEGRO DUAL

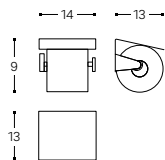

INCH 5.5x5.1x3.5



PAPER HOLDER WITH COVER
PORTAPAPEL CON TAPA

- S** **WJP036A4012001**
CHROME / CROMO
- D** **WJP036D4012001**
DUAL CHROME / CROMO DUAL

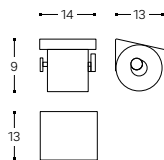

INCH 5.5x5.1x3.5



VERTICAL PAPER HOLDER
PORTAPAPEL VERTICAL

- S** **WJP043A4042001**
CHROME / CROMO
- D** **WJP043D4042001**
DUAL CHROME / CROMO DUAL
- WJP043A4042036**
BLACK / NEGRO
- D** **WJP043D4042036**
DUAL BLACK / NEGRO DUAL

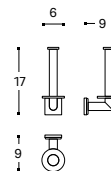

INCH 2.4x3.5x6.7



TOILET BRUSH
ESCOBILLERO

- S** **WJP036A9002001**
CHROME / CROMO
- D** **WJP036D9002001**
DUAL CHROME / CROMO DUAL
- WJP036A9002036**
BLACK / NEGRO
- D** **WJP036D9002036**
DUAL BLACK / NEGRO DUAL

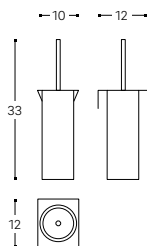

INCH 3.9x4.7x13



FREE STANDING TOILET BRUSH
ESCOBILLERO SUELO

- S** **WJP036A9051001**
CHROME / CROMO
- WJP036A9051036**
BLACK / NEGRO

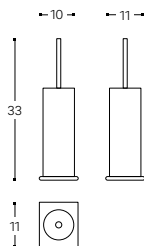

INCH 3.9x4.3x13



FREE STANDING TOILET BRUSH/PAPER HOLDER
ESCOBILLERO/PORTAPAPEL SUELO

- WJP036A1904001**
CHROME / CROMO

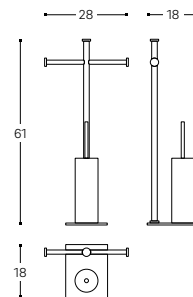

INCH 11x7.1x24





BRUSH-HOLDER
PORTACEPILLOS

WJP036A7002001
CHROME / CROMO

D **WJP036D7002001**
DUAL CHROME / CROMO DUAL

WJP036A7002036
BLACK / NEGRO

D **WJP036D7002036**
DUAL BLACK / NEGRO DUAL

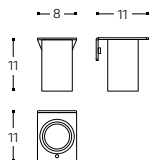

INCH 3.1x4.3x4.3



SOAP DISPENSER
DOSIFICADOR

WJP036A7805001
CHROME / CROMO

D **WJP036D7805001**
125 ML DUAL CHROME / CROMO DUAL

WJP036A7805036
BLACK / NEGRO

D **WJP036D7805036**
125 ML DUAL BLACK / NEGRO DUAL

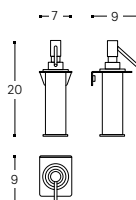

INCH 2.8x3.5x7.9



SOAP DISH
JABONERA

WJP036A6003001
CHROME / CROMO

D **WJP036D6003001**
DUAL CHROME / CROMO DUAL

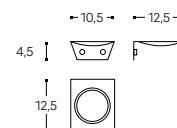

INCH 4.1x4.9x1.8



FREE STANDING BRUSH-HOLDER
PORTACEPILLOS ENCIMERA

WJP036A7050001
CHROME / CROMO

WJP036A7050036
BLACK / NEGRO

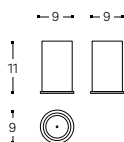

INCH 3.5x3.5x4.3



FREE STANDING SOAP DISPENSER
DOSIFICADOR ENCIMERA

WJP036A7832001
250 ML CHROME / CROMO

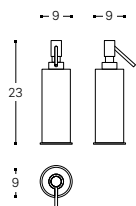

INCH 3.5x3.5x9.1



FREE STANDING SOAP DISPENSER
DOSIFICADOR ENCIMERA

WJP036A7831001
125 ML CHROME / CROMO

WJP036A7831036
125 ML BLACK / NEGRO

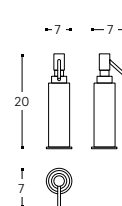

INCH 2.8x2.8x7.9

Kubic Class

Design by **Cosmic Studio**



⊙
TISSUE BOX
 CAJA KLEENEX

WJP036A9403001
 CHROME / CROMO

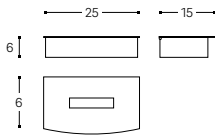

INCH 9.8x5.9x2.4



⊙○
WASTE BIN
 PAPELERA

WJP036A9351001
 CHROME / CROMO

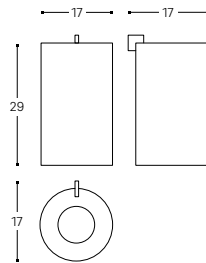

INCH 6.7x11.4



⊙△
SHOWER SEAT
 ASIENTO DUCHA
 90 KG RESISTANCE. / RESISTENCIA HASTA 90 KG.

WJP033A9230001
 CHROME / CROMO

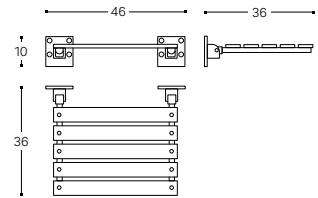

INCH 18.1x14.2x3.9





Kubic Cool

Design by **Cosmic Studio**







A contemporary classic adapted
to the most international
tastes and cutting-edge styles.

Un clásico contemporáneo adaptado
a los gustos más internacionales
y estilos más vanguardistas.













DUAL SYSTEM / SISTEMA DUAL

Our updated Kubic Cool collection now includes a dual installation system for installing bathroom accessories with or without a drill. Smart-fix adhesive, designed exclusively for our firm, means that bathroom accessories can be installed without drilling holes in the wall.

La colección Kubic Cool presenta como novedad el sistema de instalación dual, que permite sujetar los accesorios de baño con y sin taladros. Con el adhesivo Smart-fix, elaborado en exclusiva para la firma, se facilita el montaje sin la necesidad de hacer agujeros en la pared.

FEATURES / CARACTERÍSTICAS

Easy installation: double pitch screw.
Hidden attachments. Anti-corrosion.

Fácil instalación: tornillo de doble paso.
Fijaciones ocultas. Anticorrosión.



BLACK EDITION / BLACK EDITION

Cosmic brings to light a new and totally innovative finish in the bathroom sector. Black Edition is an extra-matt black finish, the result of a process widely used in the automotive sector, electrophoresis. This process provides a high resistance to scratches, uniformity in the finish and a soft and pleasant texture to the touch.

This option not only allows you to give your bathroom an elegant and trendy style, but also ensures excellent quality in each piece.

Cosmic saca a la luz un nuevo acabado totalmente innovador en el sector del baño. Black Edition es un acabado negro extra-mate, resultado de un proceso muy utilizado en el sector automovilístico, la electroforesis. Este proceso aporta una gran resistencia a las rayaduras, uniformidad en el acabado y una textura suave y agradable al tacto.

Esta opción no solo te permite darle al baño un estilo elegante y en tendencia, si no que te asegura una excelente calidad en cada pieza.



Kubic Cool has successfully passed the high demanding tests of long last durability and resistance to extreme uses (static charge or impact testing) to assure long last durability of the product. All products come with 10 years warranty, except for waste bins and stools, which come with 3 years warranty.

Toda la gama **Kubic Cool** ha superado con éxito exigentes tests de durabilidad y resistencia a usos extremos (cargas estáticas o test de impacto), para asegurar una larga vida al producto. Todos los artículos tienen 10 años de garantía a excepción de las papeleras y los taburetes que tienen una garantía de 3 años.

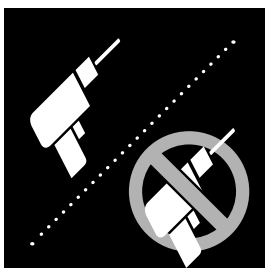

**SMART
FIX**

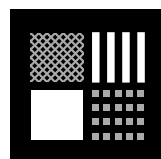

Works with different surfaces*

Efectivo en diferentes superficies*



Static load of 15 kg

Carga estática de 15 KG



Impact resistance

Resistente a impactos



Removable accessories

Accesorios removibles



Quick, easy, silent installation

Montaje sin ruido, fácil y rápido

* Ceramic, porcelain, glazed surfaces, compact marble, even surfaces with roughness up to 0.5 mm thickness.

* Cerámica, porcelana, materiales vitrificados o mármoles compactos, e incluso superficies con una rugosidad de hasta 0,5 milímetros de espesor.



⊙
HOOK
COLGADOR

- S** **WJP033A3011001**
CHROME / CROMO
- WJP033A3011036**
BLACK / NEGRO

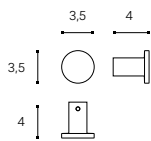

INCH 1.4x1.6x1.4



⊙
HOOK
COLGADOR

- D** **WJP033D3011001**
2U. DUAL CHROME / CROMO DUAL
- WJP033D3011036**
2U. DUAL BLACK / NEGRO DUAL

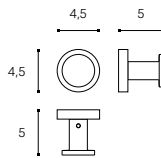

INCH 1.8x2x1.8



⊙
HOOK
COLGADOR

- S** **WJP033A3001001**
CHROME / CROMO
- WJP033A3001036**
BLACK / NEGRO

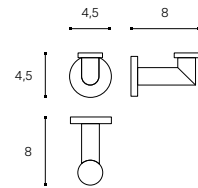

INCH 1.8x3.1x1.8



⊙
HOOK
COLGADOR

- D** **WJP033D3001001**
2U. DUAL CHROME / CROMO DUAL
- WJP033D3001036**
2U. DUAL BLACK / NEGRO DUAL

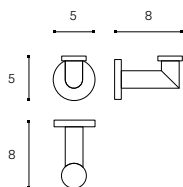

INCH 2x3.1x2



⊙
DOUBLE HOOK
COLGADOR DOBLE

- S** **WJP033A3002001**
CHROME / CROMO
- D** **WJP033D3002001**
DUAL CHROME / CROMO DUAL

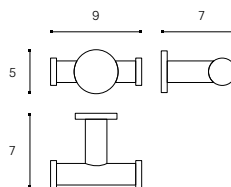

INCH 4.9x3.3x16.9



⊙
TOWEL RACK
TOALLERO

- S** **WJP033A1060001**
60 CM CHROME / CROMO
- D** **WJP033D1060001**
60 CM DUAL CHROME / CROMO DUAL
- WJP033A1060036**
60 CM BLACK / NEGRO
- D** **WJP033D1060036**
60 CM DUAL BLACK / NEGRO DUAL

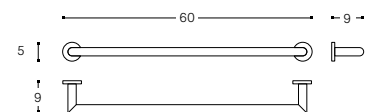

INCH 23.6x3.5x2





TOWEL RACK
TOALLERO

- S **WJP033A1050001**
50 CM CHROME / CROMO
- D **WJP033D1050001**
50 CM DUAL CHROME / CROMO DUAL

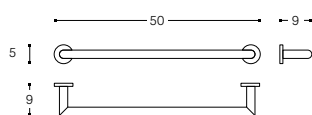

INCH 19.7x3.5x2



TOWEL RACK
TOALLERO

- S **WJP033A1040001**
40 CM CHROME / CROMO
- D **WJP033D1040001**
40 CM DUAL CHROME / CROMO DUAL
- WJP033A1040036**
40 CM BLACK / NEGRO
- D **WJP033D1040036**
40 CM DUAL BLACK / NEGRO DUAL

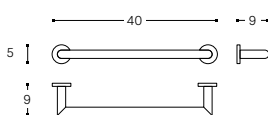

INCH 15.7x3.5x2



TOWEL RACK
TOALLERO

- S **WJP033A1030001**
30 CM CHROME / CROMO
- D **WJP033D1030001**
30 CM DUAL CHROME / CROMO DUAL
- WJP033A1030036**
30 CM BLACK / NEGRO
- D **WJP033D1030036**
30 CM DUAL BLACK / NEGRO DUAL

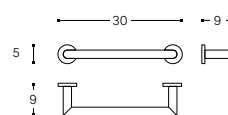

INCH 11.8x3.5x2



DOUBLE TOWEL RACK
TOALLERO DOBLE

- WJP033A1442001**
CHROME / CROMO
- D **WJP033D1442001**
DUAL CHROME / CROMO DUAL

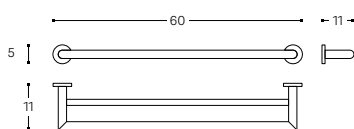

INCH 23.6x4.3x2



TOWEL RING
TOALLERO ARO

- WJP033A2055001**
CHROME / CROMO
- D **WJP033D2055001**
DUAL CHROME / CROMO DUAL

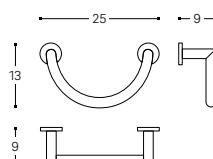

INCH 9.8x3.5x5.1



TOWEL RING
TOALLERO ARO

- WJP033A2057001**
CHROME / CROMO
- D **WJP033D2057001**
DUAL CHROME / CROMO DUAL
- WJP033A2057036**
BLACK / NEGRO
- D **WJP033D2057036**
DUAL BLACK / NEGRO DUAL

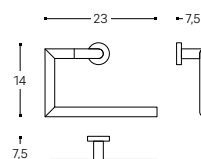

INCH 9.1x2.8x5.5



DOUBLE LATERAL TOWEL RACK
TOALLERO LATERAL DOBLE

WJP033A1401001
CHROME / CROMO

D WJP033D1401001
DUAL CHROME / CROMO DUAL

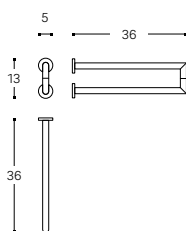

INCH 2x14.2x5.1



TOWEL RACK SHELF
TOALLERO ESTANTE

WJP033A5110001
CHROME / CROMO

D WJP033D5110001
DUAL CHROME / CROMO DUAL

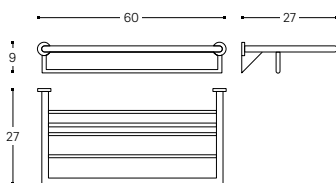

INCH 23.6x10.6x3.5



FREE STANDING TOWEL RACK
TOALLERO DE PIE

WJP036A1204001
CHROME / CROMO

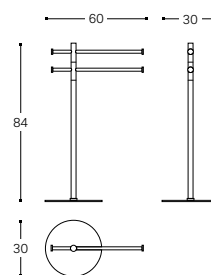

INCH 15x11.8x33.1



FREE STANDING HANGER
COLGADOR DE PIE

WJP036A3102001
CHROME / CROMO

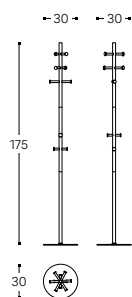

INCH 11.8x11.8x68.9



GLASS SHELF
ESTANTE VIDRIO

WJP033A5060001
60 CM CHROME / CROMO

D WJP033D5060001
60 CM DUAL CHROME / CROMO DUAL

WJP033A5040001
40 CM CHROME / CROMO

D WJP033D5040001
40 CM DUAL CHROME / CROMO DUAL

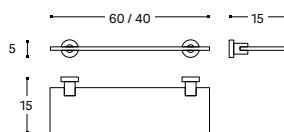

INCH 23.6/15.7x5.9x2



SOAP WIRE BASKET
JABONERA DE DUCHA

WJP033A6020001
60 CM CHROME / CROMO

D WJP033D6020001
60 CM DUAL CHROME / CROMO DUAL

WJP033A6020036
60 CM BLACK / NEGRO

D WJP033D6020036
60 CM DUAL BLACK / NEGRO DUAL

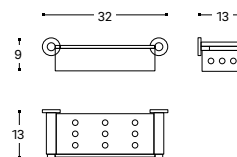

INCH 3.8x2.6x15.5





○
CORNER SHOWER WIRE BASKET
JABONERA DE DUCHA RINCÓN

WJP036A6032001
CHROME / CROMO

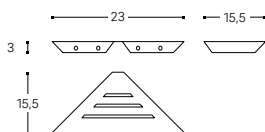

INCH 9.1x6.1x1.2



⊙
GRAB BAR
ASA BAÑERA

WJP036A0536001
CHROME / CROMO

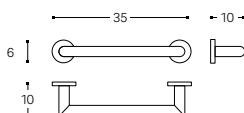

INCH 13.8x3.9x2.4



⊙
GRAB BAR
ASA BAÑERA

WJP036A0535001
CHROME / CROMO

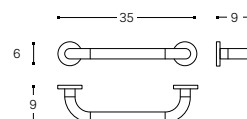

INCH 13.8x3.5x2.4



⊙
GRAB BAR
ASA BAÑERA

WJP036A0550001
CHROME / CROMO

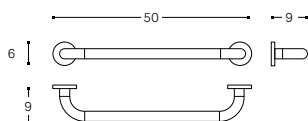

INCH 19.7x3.5x2.4



⊙
GRAB BAR
ASA BAÑERA

WJP036A0565001
CHROME / CROMO

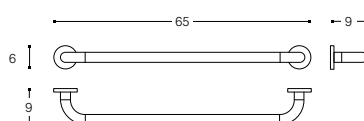

INCH 25.6x3.5x2.4



⊙
PAPER HOLDER WITHOUT COVER
PORTAPAPEL SIN TAPA

S **WJP033A1481001**
CHROME / CROMO

D **WJP033D1481001**
DUAL CHROME / CROMO DUAL

WJP033A1481001
BLACK / NEGRO

D **WJP033D1481036**
DUAL BLACK / NEGRO DUAL

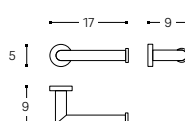

INCH 6.7x3.5x2



⊙
RIGHT PAPER HOLDER WITH COVER
PORTAPAPEL CON TAPA DERECHO

- S** **WJP036A4005001**
CHROME / CROMO
- D** **WJP036D4005001**
DUAL CHROME / CROMO DUAL
- WJP036A4005036**
BLACK / NEGRO
- D** **WJP036D4005036**
DUAL BLACK / NEGRO DUAL

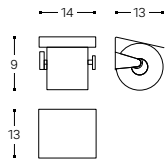

INCH 5.5x5.1x3.5



⊙
PAPER HOLDER WITH COVER
PORTAPAPEL CON TAPA

- S** **WJP036A4012001**
CHROME / CROMO
- D** **WJP036D4012001**
DUAL CHROME / CROMO DUAL

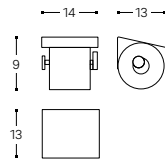

INCH 5.5x5.1x3.5



⊙
VERTICAL PAPER HOLDER
PORTAPAPEL VERTICAL

- S** **WJP033A4042001**
CHROME / CROMO
- D** **WJP033D4042001**
DUAL CHROME / CROMO DUAL
- WJP033A4042036**
BLACK / NEGRO
- D** **WJP033A4042036D**
DUAL BLACK / NEGRO DUAL

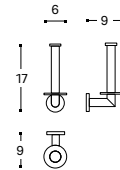

INCH 2.4x3.5x6.7



⊙
TOILET BRUSH
ESCOBILLERO

- S** **WJP036A9002001**
CHROME / CROMO
- D** **WJP036D9002001**
DUAL CHROME / CROMO DUAL
- WJP036A9002036**
BLACK / NEGRO
- D** **WJP036D9002036**
DUAL BLACK / NEGRO DUAL

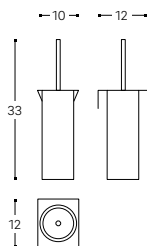

INCH 3.9x4.7x13



⊙
FREE STANDING TOILET BRUSH
ESCOBILLERO SUELO

- S** **WJP036A9051001**
CHROME / CROMO
- WJP036A9051036**
BLACK / NEGRO

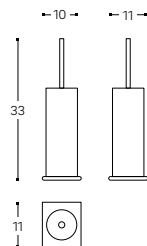

INCH 3.9x4.3x13



⊙
FREE STANDING TOILET BRUSH/PAPER HOLDER
ESCOBILLERO/PORTAPAPEL SUELO

- WJP036A1904001**
CHROME / CROMO

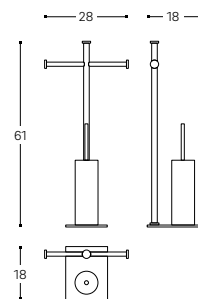

INCH 11x7.1x24





BRUSH-HOLDER
PORTACEPILLOS

WJP036A7002001
CHROME / CROMO

D WJP036D7002001
DUAL CHROME / CROMO DUAL

WJP036A7002036
BLACK / NEGRO

D WJP036D7002036
DUAL BLACK / NEGRO DUAL

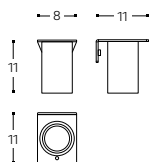

INCH 3.1x4.3x4.3



SOAP DISPENSER
DOSIFICADOR

WJP036A7805001
CHROME / CROMO

D WJP036D7805001
125 ML DUAL CHROME / CROMO DUAL

WJP036A7805036
BLACK / NEGRO

D WJP036D7805036
125 ML DUAL BLACK / NEGRO DUAL

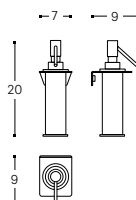

INCH 2.8x3.5x7.9



SOAP DISH
JABONERA

WJP036A6003001
CHROME / CROMO

D WJP036D6003001
DUAL CHROME / CROMO DUAL

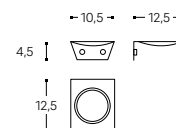

INCH 4.1x4.9x1.8



FREE STANDING BRUSH-HOLDER
PORTACEPILLOS ENCIMERA

WJP036A7050001
CHROME / CROMO

WJP036A7050036
BLACK / NEGRO

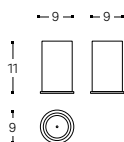

INCH 3.5x3.5x4.3



FREE STANDING SOAP DISPENSER
DOSIFICADOR ENCIMERA

WJP036A7832001
250 ML CHROME / CROMO

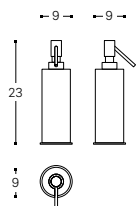

INCH 3.5x3.5x9.1



FREE STANDING SOAP DISPENSER
DOSIFICADOR ENCIMERA

WJP036A7831001
125 ML CHROME / CROMO

WJP036A7831036
125 ML BLACK / NEGRO

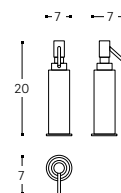

INCH 2.8x2.8x7.9

Kubic Cool

Design by **Cosmic Studio**



⊙
TISSUE BOX
 CAJA KLEENEX

WJP036A9403001
 CHROME / CROMO

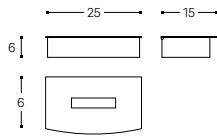

INCH 9.8x5.9x2.4



⊙○
WASTE BIN
 PAPELERA

WJP036A9351001
 CHROME / CROMO

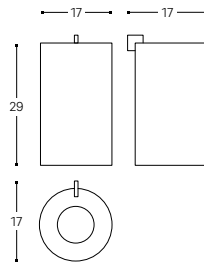

INCH 6.7x11.4



⊙△
SHOWER SEAT
 ASIENTO DUCHA
 90 KG RESISTANCE. / RESISTENCIA HASTA 90 KG.

WJP033A9230001
 CHROME / CROMO

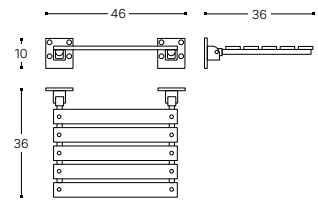

INCH 18.1x14.2x3.9





Line

Design by Ricard Ferrer









Line is an essential idea, a simple ribbon, a taut gesture that swivels and becomes a functional object. An idea that has been maintained until achieving a collection of accessories designed for today's bathroom.

Line es una idea esencial, una simple cinta, un gesto tenso que gira y se convierte en un objeto funcional. Una idea que se mantiene hasta lograr una colección de accesorios y complementos pensada para un baño actual.





QUICK FIX / QUICK FIX

Our updated Line collection now includes a dual installation system for installing bathroom accessories with or without a drill. Quick Fix adhesive, designed exclusively for our firm, means that bathroom accessories can be installed without drilling holes in the wall.

La colección Line presenta como novedad el sistema de instalación dual, que permite sujetar los accesorios de baño con y sin taladros. Con el adhesivo Quick Fix, elaborado en exclusiva para la firma, se facilita el montaje sin la necesidad de hacer agujeros en la pared.

FEATURES / CARACTERÍSTICAS

Easy installation: double pitch screw. Hidden attachments. Anti-corrosion.

Fácil instalación: tornillo de doble paso. Fijaciones ocultas. Anticorrosión.

Line has successfully passed the high demanding tests of long last durability and resistance to extreme uses (static charge or impact testing) to assure long last durability of the product. All products come with 10 years warranty.

Toda la gama Line ha superado con éxito exigentes tests de durabilidad y resistencia a usos extremos (cargas estáticas o test de impacto), para asegurar una larga vida al producto. Todos los artículos tienen 10 años de garantía.

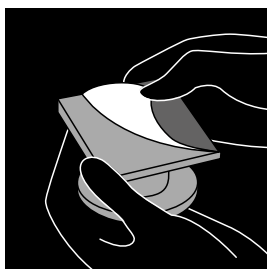

**QUICK
FIX**



Easy installation without drilling

Fácil instalación sin taladro



Bonded with high adhesion adhesive

Fijación con adhesivo de alta adherencia



Quick, easy, silent installation

Montaje sin ruido, fácil y rápido



Static load of 5 kg

Carga estática de 5 KG



Do not use on painted surfaces and gypsum walls

No usar en superficies pintadas ni en paredes rugosas





○△
HOOK
COLGADOR

S WJB269A0021001

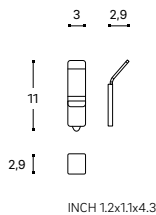

INCH 1.2x1.1x4.3



○△
FREE STANDING BRUSH-HOLDER
PORTACEPILLOS ENCIMERA

WJB269A0053001

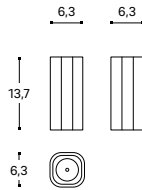

INCH 2.5x2.5x5.4



○△
FREE STANDING SOAP DISPENSER
DOSIFICADOR ENCIMERA

WJB269A0004001
370 ML CHROME / CROMO

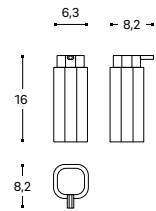

INCH 2.5x3.2x6.3



○△
CORNER SHOWER WIRE BASKET
JABONERA DE DUCHA RINCÓN

WJB269A0050001

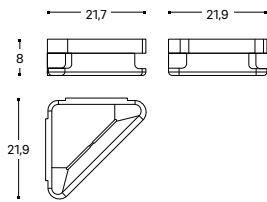

INCH 8.5x8.6x3.1



○△
SOAP WIRE BASKET
JABONERA DE DUCHA

S WJB269A0049001

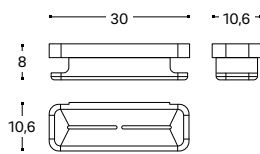

INCH 11.8x4.17x3.1



○△
TOWEL RING
TOALLERO ARO

WJB269A0071001

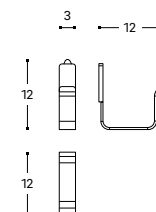

INCH 1.1x4.7x4.7

CAN BE EASILY TAKEN APART FOR CLEANING. EXTRACTABLE SOAP DISH.
FÁCIL EXTRACCIÓN PARA SU LIMPIEZA. JABONERA EXTRAÍBLE.

CAN BE EASILY TAKEN APART FOR CLEANING. EXTRACTABLE SOAP DISH.
FÁCIL EXTRACCIÓN PARA SU LIMPIEZA. JABONERA EXTRAÍBLE.





○△
TOWEL RACK
TOALLERO

- S **WJB269A0064001**
40 CM / INCH 15.7
- S **WJB269A0065001**
60 CM / INCH 23.6

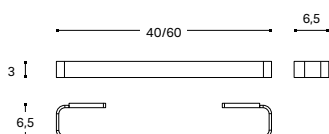

INCH 15.7/23.6x2.5x1.1



○△
TOWEL RACK SHELF
TOALLERO ESTANTE

WJB269A0068001

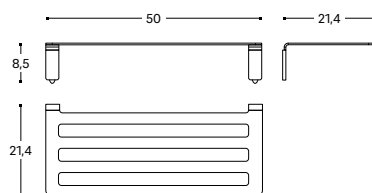

INCH 19.7x8.4x3.4



○△
PAPER HOLDER WITHOUT COVER
PORTAPEPEL SIN TAPA

S **WJB269A0058001**

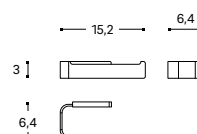

INCH 6x2.5x1.2



○△
PAPER HOLDER WITH COVER
PORTAPEPEL CON TAPA

S **WJB269A0059001**

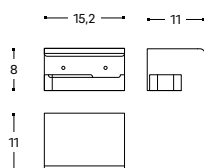

INCH 6x4.3x3.2



○△
FREE STANDING TOILET BRUSH
ESCOBILLERO SUELO

S **WJB269A0000001**

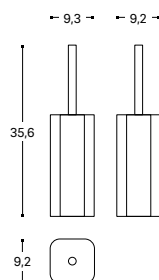

INCH 3.7x3.6x14



○△
WASTE BIN
PAPELERA

WJB269A0002002
5L GLOSSY STAINLESS STEEL / INOX BRILLO
WJB269A0002001
5L CHROME / CROMO

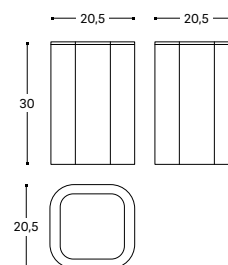

INCH 8x8x11.8

Logic

Design by **Cosmic Studio**













Highly compact black coating on stainless steel through a process of electrophoresis. Thermal hardening treatment through two phases of baking.

Revestimiento negro sobre acero inoxidable muy compacto, mediante un proceso de electroforesis. Tratamiento térmico de endurecimiento en dos fases de horneado.





Pieces that bring together the functions and basic forms of the bathroom to create comfortable and pleasant ambiances.

Piezas que recogen los usos y formas básicas del baño para crear ambientes confortables y cómodos.



Logic has successfully passed the high demanding tests of long last durability and resistance to extreme uses (static charge or impact testing) to assure long last durability of the product.

Toda la gama **Logic** ha superado con éxito exigentes tests de durabilidad y resistencia a usos extremos (cargas estáticas o test de impacto), para asegurar una larga vida al producto.



FEATURES / CARACTERÍSTICAS

Easy installation: double pitch screw.
Hidden attachments. Anti-corrosion.

Fácil instalación: tornillo de doble paso.
Fijaciones ocultas. Anticorrosión.

Optional disc (30 mm Ø) for safer installation on plasterboard walls included.

Incluido disco opcional (30 mm Ø) para una instalación más segura en paredes de yeso y cartón-yeso.

FINISHES / ACABADOS



002
Bright
Brillo



003
Matte
Mate

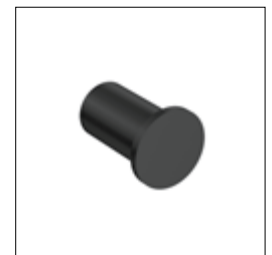

036
Soft Black
Soft Black

Smooth, consistent and pleasant to the touch

Textura suave, regular y agradable al tacto

High resistance Non-scratch

Alta resistencia a las rayadas

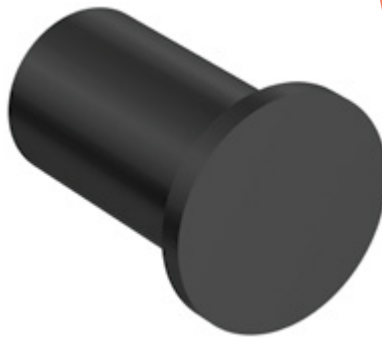

Innovation in the bathroom sector
Innovación en el sector del baño

Completely uniform finish

Uniformidad en el acabado

Soft Black

A process widely used in the automobile industry to protect bodywork

Un proceso muy utilizado en el sector automovilístico para la protección de las carrocerías

Application of a process widely used in the **automobile industry** to protect bodywork, thanks to the **research** and **development** carried out by the Cosmic team. An **innovation** in the bathroom sector. Completely **uniform** finish, which makes it **smooth, consistent** and **pleasant to the touch**. **High resistance Non-scratch**.

Aplicación de un proceso muy utilizado en el **sector automovilístico** para la protección de las carrocerías, gracias a la **investigación** y **desarrollo** realizada por el equipo de Cosmic.

Innovación en el sector del baño. **Uniformidad** en el acabado, consiguiendo una **textura suave, regular** y **agradable al tacto**. **Alta resistencia a las rayadas**.





○
HOOK *
COLGADOR *

- WJC226A0021002**
BRIGHT / BRILLO
- WJC226A0021003**
MATTE / MATE
- WJC226A0021036**
SOFT BLACK

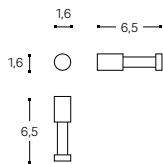

INCH 0.6x2.5x0.6



○
HOOK
COLGADOR

- WJC226A0121002**
BRIGHT / BRILLO
- WJC226A0121003**
MATTE / MATE
- WJC226A0121036**
SOFT BLACK

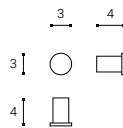

INCH 1.2x1.6x1.2



○△
FREE STANDING BRUSH-HOLDER
PORTACEPILLOS ENCIMERA

- WJC226A0051002**
BRIGHT / BRILLO
- WJC226A0051003**
MATTE / MATE
- WJC226A0051036**
SOFT BLACK

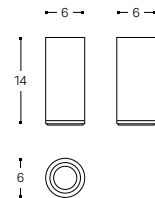

INCH 2.4x3.5x5.5



○△
BRUSH-HOLDER
PORTACEPILLOS

- WJC226A0003002**
BRIGHT / BRILLO
- WJC226A0003003**
MATTE / MATE
- WJC226A0003036**
SOFT BLACK

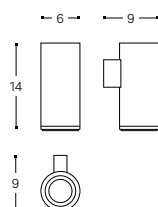

INCH 2.4x3.5x5.5



○△
FREE STANDING SOAP DISPENSER
DOSIFICADOR ENCIMERA

- WJC226A0053002**
200 ML BRIGHT / BRILLO
- WJC226A0053003**
200 ML MATTE / MATE
- WJC226A0053003**
200 ML SOFT BLACK

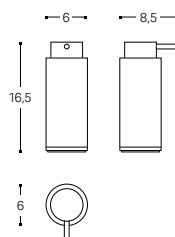

INCH 2.4x3.3x6.5



○△
SOAP DISPENSER
DOSIFICADOR

- WJC226A0004002**
200 ML BRIGHT / BRILLO
- WJC226A0004003**
200 ML MATTE / MATE
- WJC226A0004036**
200 ML SOFT BLACK

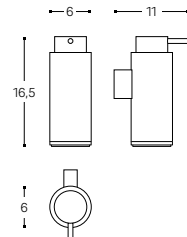

INCH 2.4x4.3x6.5





○◆
GLASS SHELF *
ESTANTE VIDRIO *

- WJC226A0044002** 30 CM
- WJC226A0045002** 57,5 CM
BRIGHT / BRILLO
- WJC226A0044003** 30 CM
- WJC226A0045003** 57,5 CM
MATTE / MATE
- WJC226A0044036** 30 CM
- WJC226A0045036** 57,5 CM
SOFT BLACK

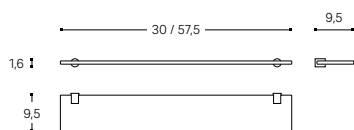

INCH 11.8/22.6x3.7x0.6



○
STAINLESS STEEL FLAT SHELF *
ESTANTE INOX *

- WJC226A0046002**
BRIGHT / BRILLO
- WJC226A0046003**
MATTE / MATE
- WJC226A0046036**
SOFT BLACK

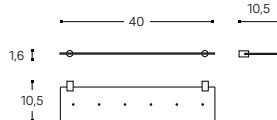

INCH 15.7x4.1x0.6



○
STAINLESS STEEL CORNER SHELF *
ESTANTE RINCÓN INOX *

- WJC226A0043002**
BRIGHT / BRILLO
- WJC226A0043003**
MATTE / MATE
- WJC226A0043036**
SOFT BLACK

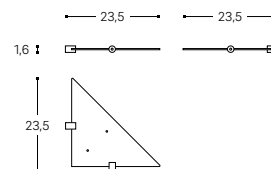

INCH 9.2x9.2x0.6



○
RACK SOAP DISH
JABONERA REJILLA

- WJC205A0039002**
GLOSSY / BRILLO
- WJC226A0039003**
MATTE / MATE
- WJC226A0039036**
SOFT BLACK

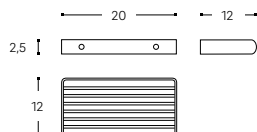

INCH 7.9x4.7x1



○
CORNER RACK SOAP DISH
JABONERA REJILLA RINCÓN

- WJC205A0030002**
GLOSSY / BRILLO
- WJC226A0039003**
MATTE / MATE
- WJC226A0030036**
SOFT BLACK

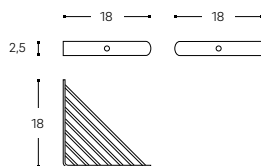

INCH 7x7x1



○
TOWEL RACK *
TOALLERO *

- WJC226A0064002**
40 CM / INCH 15.5 BRIGHT / BRILLO
- WJC226A0065002**
60 CM / INCH 23.4 BRIGHT / BRILLO
- WJC226A0064003**
40 CM / INCH 15.5 MATTE / MATE
- WJC226A0065003**
60 CM / INCH 23.4 MATTE / MATE
- WJC226A0065036**
60 CM / INCH 23.4 SOFT BLACK
- 226 36 66**
80 CM / INCH 31.3 SOFT BLACK

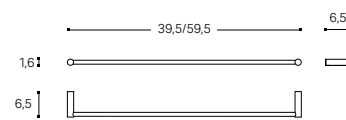

INCH 15.5/23.4x2.5x0.8



DOUBLE TOWEL RACK *
TOALLERO DOBLE *

- WJC226A0061002**
BRIGHT / BRILLO
- WJC226A0061003**
MATTE / MATE
- WJC226A0061036**
SOFT BLACK

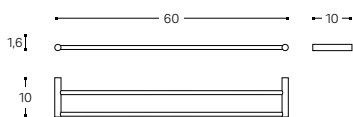

INCH 23.6x3.9x0.6



SWIVEL TOWEL RACK *
TOALLERO GIRATORIO *

- WJC226A0074002**
BRIGHT / BRILLO
- WJC226A0074003**
MATTE / MATE
- WJC226A0074036**
SOFT BLACK

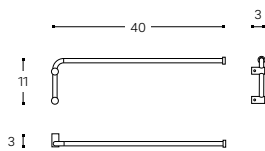

INCH 15.7x1.2x4.3



TOWEL RING *
TOALLERO ARO *

- WJC226A0072002**
BRIGHT / BRILLO
- WJC226A0072003**
MATTE / MATE
- WJC226A0072036**
SOFT BLACK

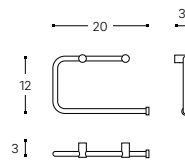

INCH 7.9x1.2x4.7

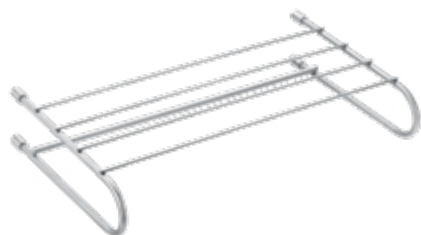

TOWEL RACK SHELF
TOALLERO ESTANTE

- WJC226A0068002**
BRIGHT / BRILLO
- WJC226A0068003**
MATTE / MATE

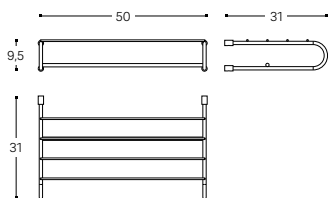

INCH 19.7x12.2x3.7



PAPER HOLDER / TOWEL RACK *
PORTAPEPEL / TOALLERO *

- WJC226A0054002**
BRIGHT / BRILLO
- WJC226A0054003**
MATTE / MATE
- WJC226A0054036**
SOFT BLACK

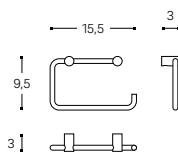

INCH 6.1x1.2x3.7



PAPER HOLDER WITH COVER
PORTAPEPEL CON TAPA

- WJC226A0059002**
BRIGHT / BRILLO
- WJC226A0059003**
MATTE / MATE
- WJC226A0059036**
SOFT BLACK

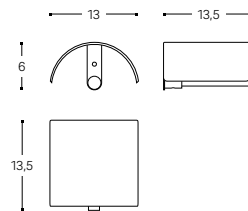

INCH 5.1x5.3x2.4



○
PAPER HOLDER WITH COVER
PORTAPEPEL CON TAPA

- WJC226A0159002**
BRIGHT / BRILLO
- WJC226A0159003**
MATTE / MATE
- WJC226A0159036**
SOFT BLACK

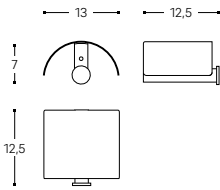

INCH 5.1x4.9x2.7



○
PAPER HOLDER WITHOUT COVER *
PORTAPEPEL SIN TAPA *

- WJC226A0058002**
BRIGHT / BRILLO
- WJC226A0058003**
MATTE / MATE
- WJC226A0058036**
SOFT BLACK

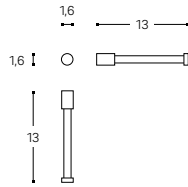

INCH 0.6x5.1x0.6



○
PAPER HOLDER WITHOUT COVER
PORTAPEPEL SIN TAPA

- WJC226A0158002**
BRIGHT / BRILLO
- WJC226A0158003**
MATTE / MATE
- WJC226A0158036**
SOFT BLACK

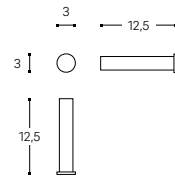

INCH 1.2x4.9x1.2



○
DOUBLE PAPER HOLDER WITHOUT COVER *
PORTAPEPEL DOBLE SIN TAPA *

- WJC226A0057002**
BRIGHT / BRILLO
- WJC226A0057003**
MATTE / MATE
- WJC226A0057036**
SOFT BLACK

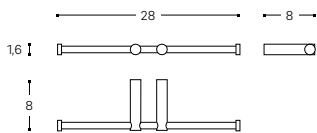

INCH 11x3.1x0.6



○
PAPER HOLDER WITHOUT COVER *
PORTAPEPEL SIN TAPA *

- WJC226A0056002**
BRIGHT / BRILLO
- WJC226A0056003**
MATTE / MATE
- WJC226A0056036**
SOFT BLACK

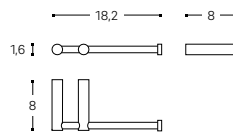

INCH 7.2x3.1x0.6



○△
TOILET BRUSH FLOOR / WALL
ESCOBILLERO SUELO/PARED

- WJC226A0000098**
NEGRO-MATE / BLACK-MATTE

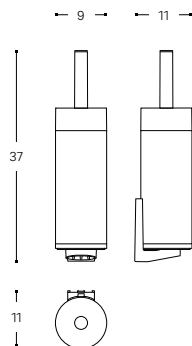

INCH 3.5x4.3x14.5

* OPTIONAL DISC (30 MM Ø) FOR SAFER INSTALLATION ON PLASTERBOARD WALLS INCLUDED.
* INCLUIDO DISCO OPCIONAL (30 MM Ø) PARA UNA INSTALACIÓN MÁS SEGURA EN PAREDES DE YESO Y CARTÓN-YESO.



FREE STANDING TOILET BRUSH
 ESCOBILLERO SUELO

WJC226A0001002
 BRIGHT / BRILLO

WJC226A0001003
 MATTE / MATE

WJC226A0001036
 SOFT BLACK

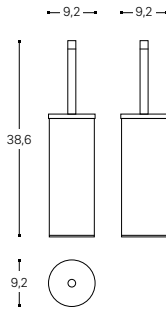

INCH 3.6x3.6x15.2



TOILET BRUSH
 ESCOBILLERO

WJC226A0097002
 BRIGHT / BRILLO

WJC226A0097003
 MATTE / MATE

WJC226A0097036
 SOFT BLACK

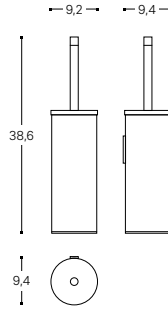

INCH 3.6x3.7x15.2





Metric

Design by **Cosmic Studio**











The avant-garde of minimalist design converted into a classic.

La vanguardia del diseño minimalista convertido en un clásico.









FEATURES / CARACTERÍSTICAS

Easy installation: double pitch screw.
Hidden attachments. Anti-corrosion.

Fácil instalación: tornillo de doble paso.
Fijaciones ocultas. Anticorrosión.



BLACK EDITION / BLACK EDITION

Cosmic brings to light a new and totally innovative finish in the bathroom sector. Black Edition is an extra-matt black finish, the result of a process widely used in the automotive sector, electrophoresis. This process provides a high resistance to scratches, uniformity in the finish and a soft and pleasant texture to the touch.

This option not only allows you to give your bathroom an elegant and trendy style, but also ensures excellent quality in each piece.

Cosmic saca a la luz un nuevo acabado totalmente innovador en el sector del baño. Black Edition es un acabado negro extra-mate, resultado de un proceso muy utilizado en el sector automovilístico, la electroforesis. Este proceso aporta una gran resistencia a las rayaduras, uniformidad en el acabado y una textura suave y agradable al tacto.

Esta opción no solo te permite darle al baño un estilo elegante y en tendencia, si no que te asegura una excelente calidad en cada pieza.



Metric has successfully passed the high demanding tests of long last durability and resistance to extreme uses (static charge or impact testing) to assure long last durability of the product. All products come with 10 years warranty.

Toda la gama **Metric** ha superado con éxito exigentes tests de durabilidad y resistencia a usos extremos (cargas estáticas o test de impacto), para asegurar una larga vida al producto. Todos los artículos tienen 10 años de garantía.

FINISHES / ACABADOS

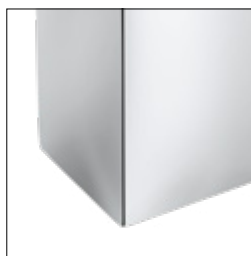

001
Chrome
Cromo



021
Stainless Steel
Inox

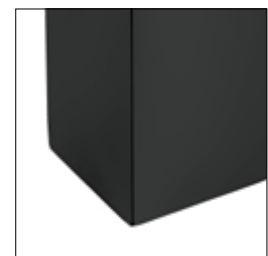

036
Matte black
Negro mate





⊙
HOOK
COLGADOR

- Ⓢ **WJP038A3001001**
CHROME / CROMO
- Ⓢ **WJP038A3001021**
STAINLESS STEEL / INOX
- WJP038A3001036**
BLACK / NEGRO

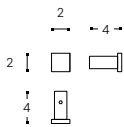

INCH 0.8x1.6x0.8



⊙
DOUBLE HOOK
COLGADOR DOBLE

- Ⓢ **WJP038A3002001**
CHROME / CROMO
- WJP038A3002021**
STAINLESS STEEL / INOX

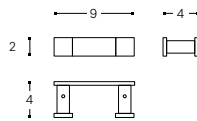

INCH 3.5x1.6x0.8



⊙
TOWEL RACK
TOALLERO

- Ⓢ **WJP038A1060001**
60 CM CHROME / CROMO
- Ⓢ **WJP038A1060021**
60 CM STAINLESS STEEL / INOX
- WJP038A1060036**
60 CM BLACK / NEGRO
- Ⓢ **WJP038A1040001**
40 CM CHROME / CROMO
- Ⓢ **WJP038A1040021**
40 CM STAINLESS STEEL / INOX
- WJP038A1040036**
40 CM BLACK / NEGRO

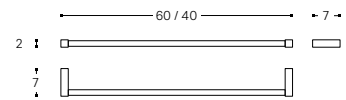

INCH 23.6/15.7x2.8x0.8



⊙
TOWEL RACK
TOALLERO

- Ⓢ **WJP038A1050001**
50 CM CHROME / CROMO
- WJP038A1050036**
50 CM BLACK / NEGRO
- Ⓢ **WJP038A1030001**
30 CM CHROME / CROMO
- WJP038A1030036**
30 CM BLACK / NEGRO

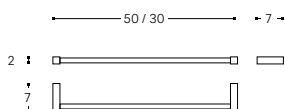

INCH 19.7/11.8x7.9x3.4



⊙
TOWEL RACK
TOALLERO

- WJP038A1481001**
CHROME / CROMO
- WJP038A1481021**
STAINLESS STEEL / INOX

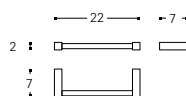

INCH 8.7x2.8x0.8



⊙
DOUBLE TOWEL RACK
TOALLERO DOBLE

- WJP038A1442001**
60 CM CHROME / CROMO
- WJP038A1443001**
50 CM CHROME / CROMO
- WJP038A1443021**
50 CM STAINLESS STEEL / INOX

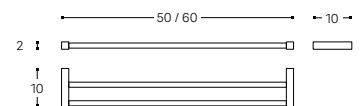

INCH 23.6/19.7x3.9x0.8



TOWEL RING
TOALLERO ARO

WJP038A2005001
CHROME / CROMO

WJP038A2005021
STAINLESS STEEL / INOX

WJP038A2005036
BLACK / NEGRO

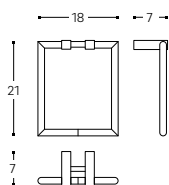

INCH 7.1x2.8x8.3



DOUBLE LATERAL TOWEL RACK
TOALLERO LATERAL DOBLE

WJP038A1401001
CHROME / CROMO

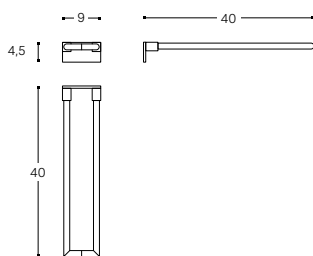

INCH 3.5x15.7x1.8



TOWEL RACK SHELF
TOALLERO ESTANTE

WJP038A5110001
CHROME / CROMO

WJP038A5110036
BLACK / NEGRO

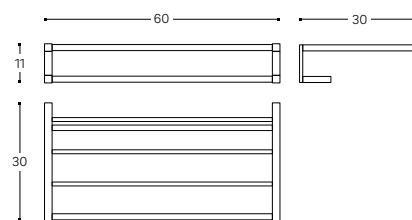

INCH 23.6x11.8x4.3



SHELF
ESTANTE

WJP038A5060001
60 CM CHROME / CROMO

WJP038A5040001
40 CM CHROME / CROMO

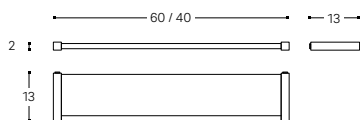

INCH 23.6/15.7x4.7x0.8



SOAP WIRE BASKET
JABONERA DE DUCHA

WJP038A6020001
CHROME / CROMO

WJP038A6020021
STAINLESS STEEL / INOX

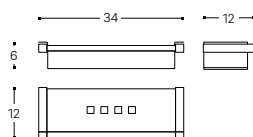

INCH 13.4x4.7x2.4



SOAP WIRE BASKET
JABONERA DE DUCHA

WJP038A6010001
CHROME / CROMO

WJP038A6010036
BLACK / NEGRO

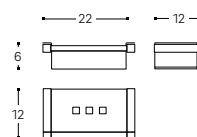

INCH 8.7x4.7x2.4



○
CORNER SHOWER WIRE BASKET
JABONERA DE DUCHA RINCÓN

WJP038A6030001
CHROME / CROMO

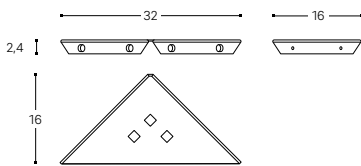

INCH 12.6x6.3x0.9



⊙
RIGHT PAPER HOLDER WITHOUT COVER
PORTAPAPEL SIN TAPA DERECHO

Ⓢ **WJP038A4002001**
CHROME / CROMO
Ⓢ **WJP038A4002021**
STAINLESS STEEL / INOX
WJP038A4002036
BLACK / NEGRO

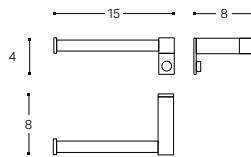

INCH 5.9x3.1x1.6



⊙
LEFT PAPER HOLDER WITHOUT COVER
PORTAPAPEL SIN TAPA IZQUIERDO

Ⓢ **WJP038A4010001**
CHROME / CROMO
WJP038A4010036
BLACK / NEGRO

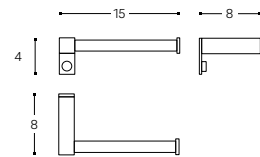

INCH 5.9x3.1x1.6



⊙
DOUBLE PAPER HOLDER WITHOUT COVER
PORTAPAPEL DOBLE SIN TAPA

WJP038A4020001
CHROME / CROMO

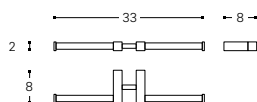

INCH 11.8x3.2x0.8



⊙
VERTICAL PAPER HOLDER
PORTAPAPEL VERTICAL

Ⓢ **WJP038A4042001**
CHROME / CROMO
WJP038A4042021
STAINLESS STEEL / INOX
WJP038A4042036
BLACK / NEGRO

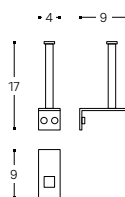

INCH 1.6x3.5x6.7



⊙
PAPER HOLDER WITHOUT COVER
PORTAPAPEL SIN TAPA

Ⓢ **WJP038A4001001**
CHROME / CROMO
WJP038A4001021
STAINLESS STEEL / INOX
WJP038A4001036
BLACK / NEGRO

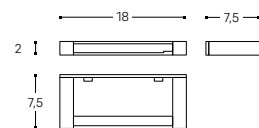

INCH 7.1x3x0.8





TOILET BRUSH
ESCOBILLERO

S **WJP038A9001001**
CHROME / CROMO

S **WJP038A9001021**
STAINLESS STEEL / INOX

WJP038A9001036
BLACK / NEGRO

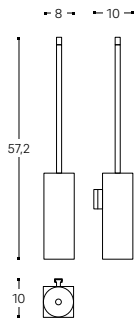

INCH 3.1x3.5x23.2



FREE STANDING TOILET BRUSH
ESCOBILLERO SUELO

WJP038A9050001
CHROME / CROMO

WJP038A9050021
STAINLESS STEEL / INOX

WJP038A9050036
BLACK / NEGRO

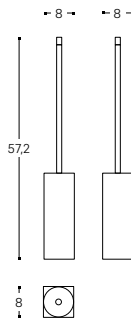

INCH 3.1x3.1x23.2



FREE STANDING TOILET BRUSH/PAPER HOLDER
ESCOBILLERO SUELO/PORTAPAPEL

WJP038A1901001
CHROME / CROMO

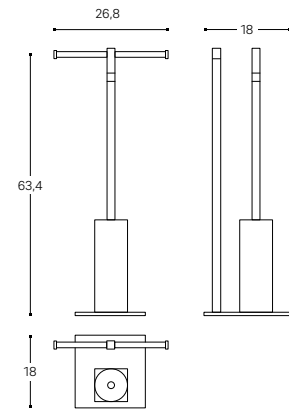

INCH 10.6x7.1x25.2



BRUSH-HOLDER
PORTACEPILLOS

WJP038A7001001
CHROME / CROMO

WJP038A7001021
STAINLESS STEEL / INOX

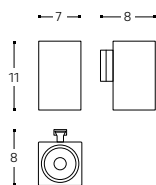

INCH 9.8x4.7x4.3



SOAP DISPENSER
DOSIFICADOR

WJP038A7801001
125 ML CHROME / CROMO

WJP038A7801021
125 ML STAINLESS STEEL / INOX

WJP038A7801036
125 ML BLACK / NEGRO

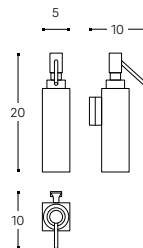

INCH 2x4x7.9



SOAP DISH
JABONERA

WJP038A6001001
CHROME / CROMO

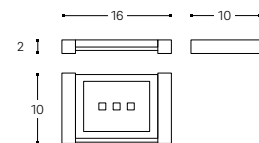

INCH 6.3x3.9x0.8



SOAP DISH
JABONERA

WJP038A6001021
STAINLESS STEEL / INOX

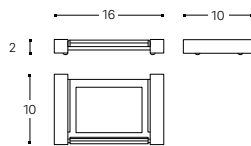

INCH 6.3x3.9x0.8



FREE STANDING BRUSH-HOLDER
PORTACEPILLOS ENCIMERA

WJP038A7050001
CHROME / CROMO

WJP038A7050021
STAINLESS STEEL / INOX

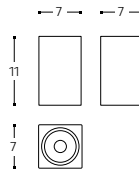

INCH 2.8x2.8x4.3



FREE STANDING SOAP DISPENSER
DOSIFICADOR ENCIMERA

WJP038A7831001
125 ML CHROME / CROMO

WJP038A7831021
125 ML STAINLESS STEEL / INOX

WJP038A7831036
125 ML BLACK / NEGRO

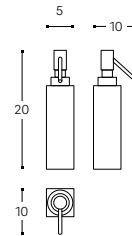

INCH 2x3.9x7.9



FREE STANDING SOAP DISH
JABONERA ENCIMERA

WJP038A6051001
CHROME / CROMO

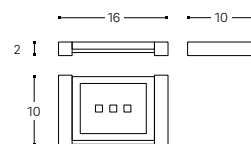

INCH 6.3x3.9x0.8





Micra

Design by Cosmic Studio







Micra's discrete proportions convey a fresh and vibrant character.

Sus discretas proporciones le confieren un carácter fresco y vibrante.













FEATURES / CARACTERÍSTICAS

Easy installation: double pitch screw.
Hidden attachments. Anti-corrosion.

Fácil instalación: tornillo de doble paso.
Fijaciones ocultas. Anticorrosión.

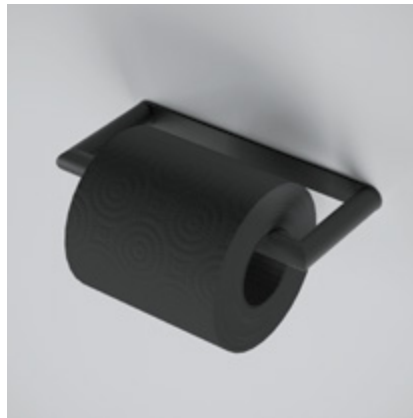

BLACK EDITION / BLACK EDITION

Cosmic brings to light a new and totally innovative finish in the bathroom sector. Black Edition is an extra-matt black finish, the result of a process widely used in the automotive sector, electrophoresis. This process provides a high resistance to scratches, uniformity in the finish and a soft and pleasant texture to the touch.

This option not only allows you to give your bathroom an elegant and trendy style, but also ensures excellent quality in each piece.

Cosmic saca a la luz un nuevo acabado totalmente innovador en el sector del baño. Black Edition es un acabado negro extra-mate, resultado de un proceso muy utilizado en el sector automovilístico, la electroforesis. Este proceso aporta una gran resistencia a las rayaduras, uniformidad en el acabado y una textura suave y agradable al tacto.

Esta opción no solo te permite darle al baño un estilo elegante y en tendencia, si no que te asegura una excelente calidad en cada pieza.



Micra has successfully passed the high demanding tests of long last durability and resistance to extreme uses (static charge or impact testing) to assure long last durability of the product. All products come with 10 years warranty, except for waste bins and stools, which come with 3 years warranty.

Toda la gama **Micra** ha superado con éxito exigentes tests de durabilidad y resistencia a usos extremos (cargas estáticas o test de impacto), para asegurar una larga vida al producto. Todos los artículos tienen 10 años de garantía a excepción de las papeleras y los taburetes que tienen una garantía de 3 años.

FINISHES / ACABADOS

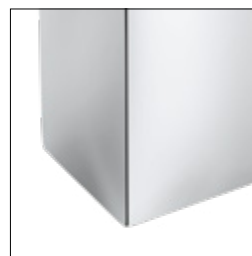

001
Chrome
Cromo

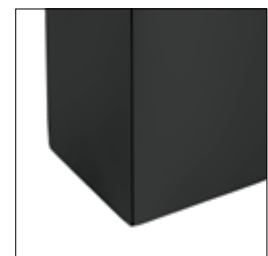

036
Soft black
Soft black





⊙
HOOK
 COLGADOR

- Ⓢ **WJP047A3001001**
 CHROME / CROMO
- WJP047A3001036**
 BLACK / NEGRO

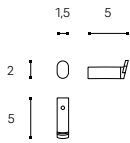

INCH 0.6x2x0.8



⊙
DOUBLE HOOK
 COLGADOR DOBLE

- Ⓢ **WJP047A3002001**
 CHROME / CROMO

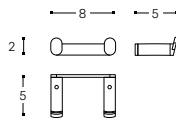

INCH 3.1x2x0.8



⊙
HOOK
 COLGADOR

- WJP047A3003001**
 CHROME / CROMO

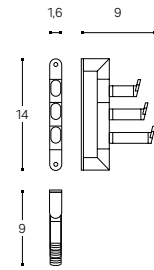

INCH 0.6x3.5x5.5



⊙
TOWEL RACK
 TOALLERO

- Ⓢ **WJP047A1050001**
 50 CM CHROME / CROMO
- WJP047A1050036**
 50 CM BLACK / NEGRO
- Ⓢ **WJP047A1040001**
 40 CM CHROME / CROMO
- WJP047A1040036**
 40 CM BLACK / NEGRO
- Ⓢ **WJP047A1030001**
 30 CM CHROME / CROMO
- WJP047A1030036**
 30 CM BLACK / NEGRO

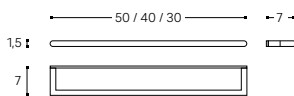

INCH 19.7/15.7/11.8x2.8x0.6



⊙
DOUBLE TOWEL RACK
 TOALLERO DOBLE

- WJP047A1443001**
 CHROME / CROMO

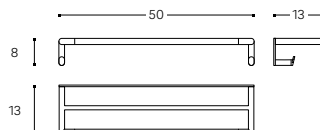

INCH 19.7x4.9x3.1



⊙
TOWEL RING
 TOALLERO ARO

- Ⓢ **WJP047A2055001**
 CHROME / CROMO
- WJP047A2055036**
 BLACK / NEGRO

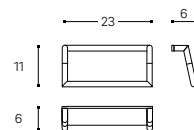

INCH 9.1x2.4x4.3





DOUBLE LATERAL TOWEL RACK
TOALLERO LATERAL DOBLE

WJP047A1401001
CHROME / CROMO

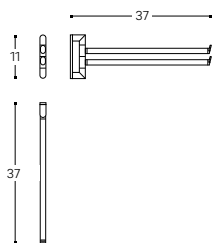

INCH 14.2x2.4



TOWEL RACK SHELF
TOALLERO ESTANTE

WJP047A5110002
CHROME / CROMO

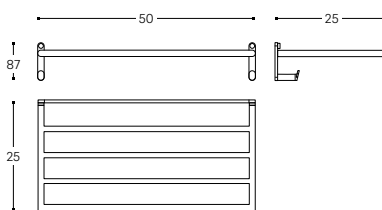

INCH 19.7x10x3.1



SHELF
ESTANTE

WJP047A5040001
CHROME / CROMO

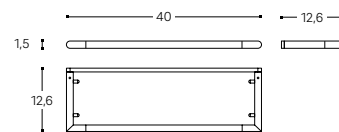

INCH 15.7x4.9x0.6



SOAP WIRE BASKET
JABONERA DE DUCHA

WJP047A6020001
CHROME / CROMO
WJP047A6020036
BLACK / NEGRO

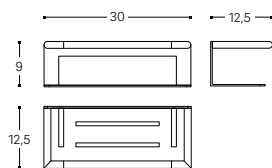

INCH 11.8x4.9x3.5



RIGHT PAPER HOLDER WITHOUT COVER
PORTAPAPEL SIN TAPA DERECHO

WJP047A4001001
CHROME / CROMO
WJP047A4001024
BLACK / NEGRO

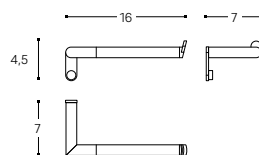

INCH 6.3x2.8x1.8



LEFT PAPER HOLDER WITHOUT COVER
PORTAPAPEL SIN TAPA IZQUIERDO

WJP047A4010001
CHROME / CROMO
WJP047A4010036
BLACK / NEGRO

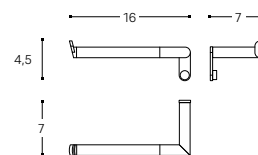

INCH 6.3x2.8x1.8



⊙
PAPER HOLDER WITHOUT COVER
PORTAPAPEL SIN TAPA

WJP047A4002001
CHROME / CROMO
WJP047A4002036
BLACK / NEGRO

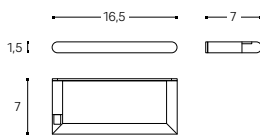

INCH 8.7x8.7x0.9



⊙△
TOILET BRUSH
ESCOBILLERO

WJP047A9001001
CHROME / CROMO
WJP047A9001036
BLACK / NEGRO

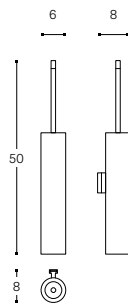

INCH 2.4x3.2x19.7



⊙△
FREE STANDING TOILET BRUSH
ESCOBILLERO SUELO

WJP047A9050001
CHROME / CROMO
WJP047A9050024
BLACK / NEGRO

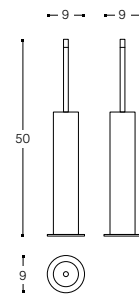

INCH 3.6x3.6x19.2



⊙
BRUSH-HOLDER
PORTACEPILLOS

WJP047A7001001
CHROME / CROMO

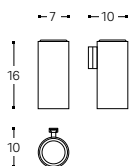

INCH 3.1x3.9x6.3



⊙△
SOAP DISPENSER
DOSIFICADOR

WJP047A7802001
250 ML CHROME / CROMO
WJP047A7802036
250 ML BLACK / NEGRO

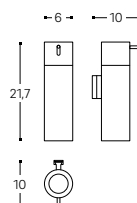

INCH 2.4x3x8.3



⊙
SOAP DISH
JABONERA

WJP047A6001001
CHROME / CROMO

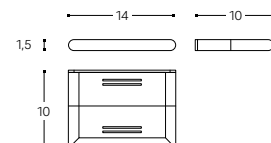

INCH 5.5x3.9x0.6





FREE STANDING BRUSH-HOLDER
PORTACEPILLOS ENCIMERA

WJP047A7050001
CHROME / CROMO

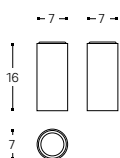

INCH 3.1x3.1x6.3



FREE STANDING SOAP DISPENSER
DOSIFICADOR ENCIMERA

WJP047A7832001
250 ML CHROME / CROMO
WJP047A7832036
250 ML BLACK / NEGRO

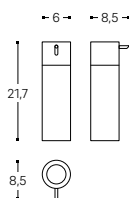

INCH 2.4x3x8.3



FREE STANDING SOAP DISH
JABONERA ENCIMERA

WJP047A6050001
CHROME / CROMO

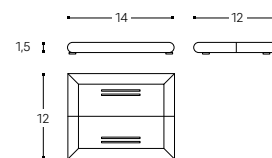

INCH 5.5x4.7x0.6



Minimalism

Design by **Cosmic Studio**

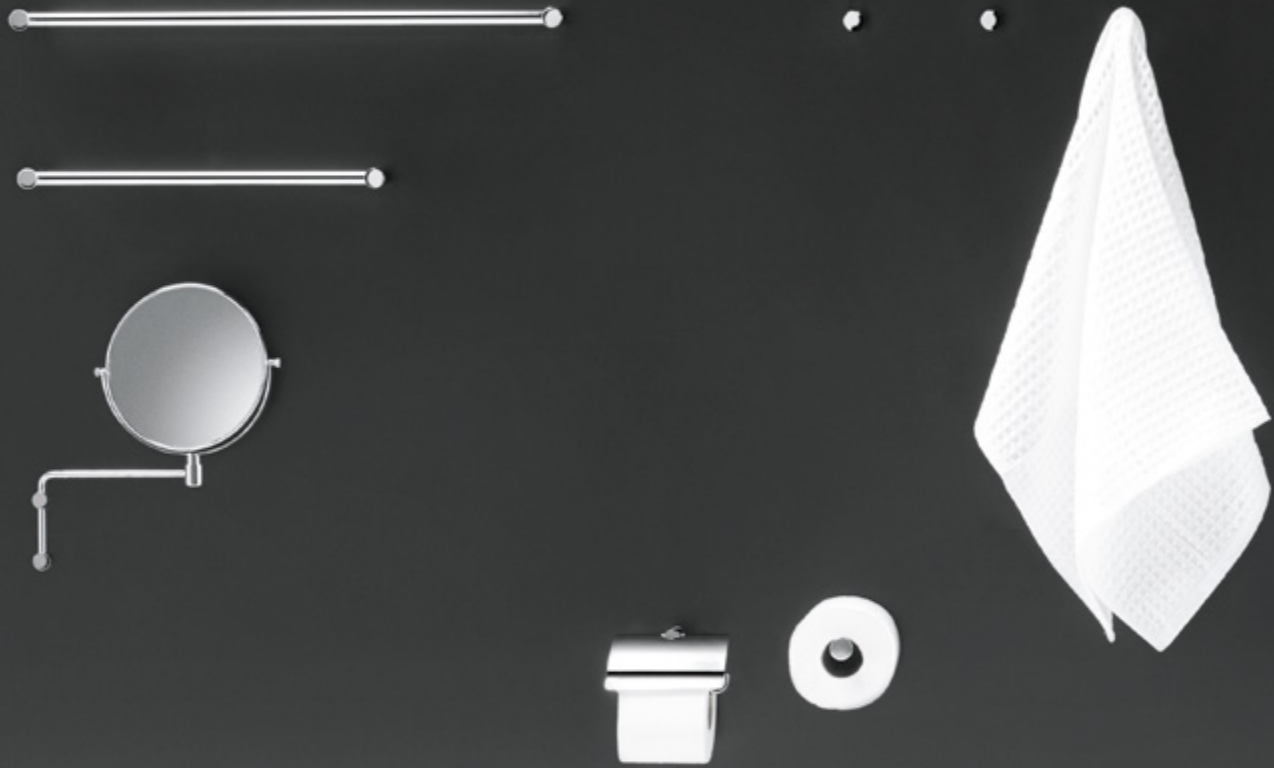





Maximum wellbeing in
the bathroom environment
with minimum elements.

El máximo bienestar
en el entorno del baño
con mínimos elementos.





Minimalism

Design by Cosmic Studio





Minimalism has successfully passed the high demanding tests of long last durability and resistance to extreme uses (static charge or impact testing) to assure long last durability of the product.

Toda la gama **Minimalism** ha superado con éxito exigentes tests de durabilidad y resistencia a usos extremos (cargas estáticas o test de impacto), para asegurar una larga vida al producto.



FEATURES / CARACTERÍSTICAS

Easy installation: double pitch screw.
Hidden attachments. Anti-corrosion.

Fácil instalación: tornillo de doble paso.
Fijaciones ocultas. Anticorrosión.





⊙
HOOK
COLGADOR

WJC240A0021001

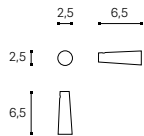

INCH 1x2.5x1



⊙△
FREE STANDING BRUSH-HOLDER
PORTACEPILLOS ENCIMERA

WJC251A0053001

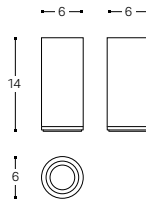

INCH 2.4x2.4x5.5



⊙△
BRUSH-HOLDER
PORTACEPILLOS

WJC251A0054001

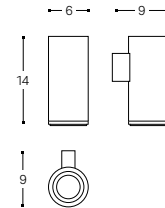

INCH 2.4x3.5x5.5



⊙△
FREE STANDING SOAP DISPENSER
DOSIFICADOR ENCIMERA

WJC251A0004001
200 ML

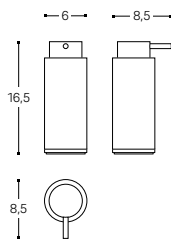

INCH 2.4x3.3x6.5



⊙△
SOAP DISPENSER
DOSIFICADOR

WJC251A0005001
200 ML

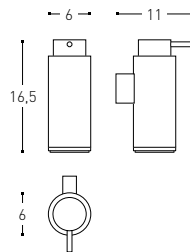

INCH 2.4x4.3x6.5



⊙◇
WALL MAGNIFYING MIRROR (X1/X3)
ESPEJO DE AUMENTO PARED (X1/X3)

WJC240A0086001

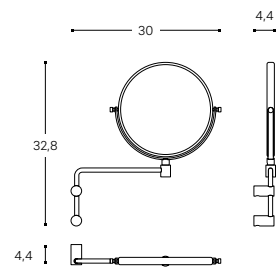

INCH 11.8x1.7x12.9





◆
GLASS SHELF
ESTANTE VIDRIO

WJC240A0045001

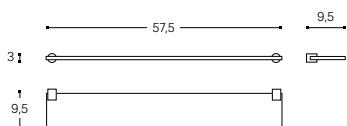

INCH 22.6x3.7x1.2



○
SHELF
ESTANTE

WJC240A0046001

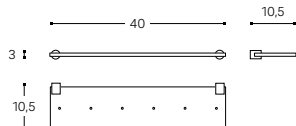

INCH 15.7x4.1x1.2



○
STAINLESS STEEL CORNER SHELF
ESTANTE RINCÓN INOX

WJC240A0043001

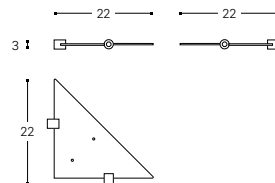

INCH 8.7x8.7x1.2



○
SOAP WIRE BASKET
JABONERA DE DUCHA

WJC240A0049001

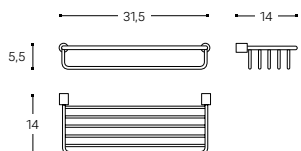

INCH 12.4x5.5x2.2



○
SOAP WIRE BASKET
JABONERA DE DUCHA

WJC240A0048001

41 CM / INCH 16.1

WJC240A0088001

51 CM / INCH 20.1

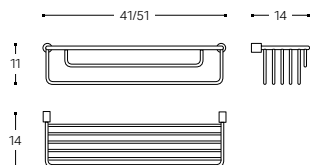

INCH 16.1/20.1x5.5x4.3



○
CORNER SHOWER WIRE BASKET
JABONERA DE DUCHA RINCÓN

WJC240A0050001

5.5 CM / INCH 2.2

WJC240A0089001

9 CM / INCH 3.5

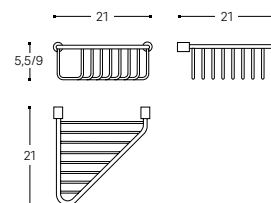

INCH 8.3x8.3x2.2/3.5



Minimalism

Design by **Cosmic Studio**

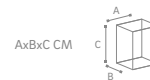

⊙
TOWEL RACK
TOALLERO

WJC240A0064001
41,5 CM / INCH 16.3

WJC240A0065001
61,5 CM / INCH 24.2

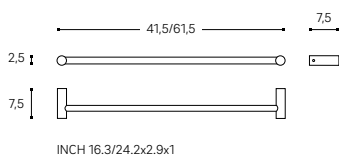

⊙
DOUBLE TOWEL RACK
TOALLERO DOBLE

WJC240A0061001

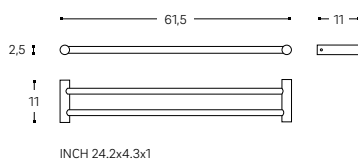

⊙
SWIVEL DOUBLE TOWEL RACK
TOALLERO DOBLE GIRATORIO

WJC240A0075001

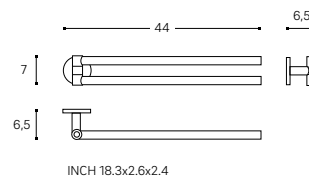

⊙
TOWEL RING
TOALLERO ARO

WJC240A0071001
16X5X17 CM / INCH 6.3X2X6.7

WJC240A0072001
21X5X22 CM / INCH 8.3X2X8.7

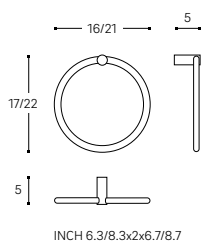

⊙
TOWEL RACK SHELF
TOALLERO ESTANTE

WJC240A0068001

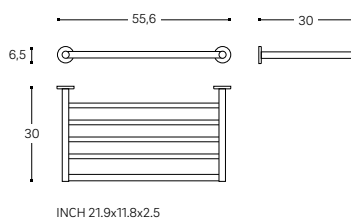

⊙
PAPER HOLDER WITH COVER
PORTAPAPEL CON TAPA

WJC240A0059001

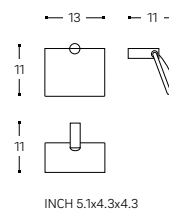



⊙
PAPER HOLDER WITHOUT COVER
PORTAPAPEL SIN TAPA

WJC240A0058001

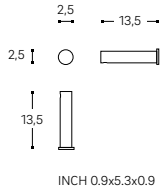

⊙
SET OF 2 SHELF HOLDERS
JUEGO 2 SOPORTES ESTANTE

WJC240A0080001

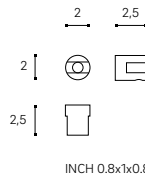

⊙◇
TOILET BRUSH
ESCABILERO

WJC240A0000001

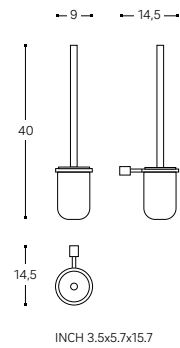

⊙○△
FREE-STANDING OR WALL TOILET BRUSH
ESCABILERO SUELO/PARED

WJC251A0000001

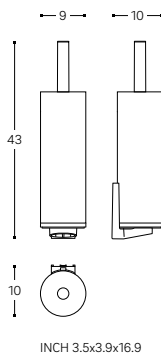

○△
STOOL
TABURETE

WJC205A0006065
CHROME-MATTE WHITE / CROMO-BLANCO MATE
WJC205A0006036
CHROME-MATTE BLACK / CROMO-NEGRO MATE

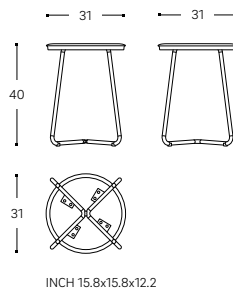

Project

Design by **Cosmic Studio**









From the amalgamation
of circular and squared forms
comes the versatility and
functionality of all its elements.

De la conjugación de formas
circulares y cuadradas, surge
la versatilidad y funcionalidad
de todos sus elementos.





Project has successfully passed the high demanding tests of long last durability and resistance to extreme uses (static charge or impact testing) to assure long last durability of the product.

Toda la gama **Project** ha superado con éxito exigentes tests de durabilidad y resistencia a usos extremos (cargas estáticas o test de impacto), para asegurar una larga vida al producto.



FEATURES / CARACTERÍSTICAS

Easy installation: double pitch screw.
Hidden attachments. Support bars:
reinforced design for disabled people: 150kg.
Anti-corrosion.

Fácil instalación: tornillo de doble paso.
Fijaciones ocultas. Barras de apoyo: diseño
reforzado para minusvalías: 150 kgs.
Anticorrosión.

FINISHES / ACABADOS



001
Chrome
Cromo



051
Chrome-White
Cromo-Blanco



061
Chrome-Black
Cromo-Negro



⊙
HOOK
COLGADOR

S **WJC251A0021001**

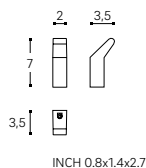

INCH 0.8x1.4x2.7



⊙△
FREE STANDING SOAP DISH
JABONERA ENCIMERA

WJC251A0034051
CHROME-WHITE / CROMO-BLANCO

WJC251A0034061
CHROME-BLACK / CROMO-NEGRO

WJC251A0034001
CHROME / CROMO

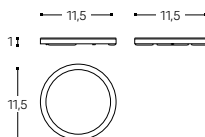

INCH 4.5x4.5x0.4



⊙△
SOAP DISH
JABONERA

WJC251A0032051
CHROME-WHITE / CROMO-BLANCO

WJC251A0032061
CHROME-BLACK / CROMO-NEGRO

WJC251A0032001
CHROME / CROMO

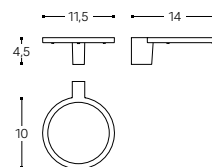

INCH 4.5x5.5x1.8



⊙△
FREE STANDING BRUSH-HOLDER
PORTACEPILLOS ENCIMERA

WJC251A0053001

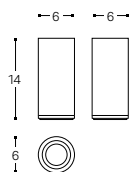

INCH 2.4x2.4x5.5



⊙△
BRUSH-HOLDER
PORTACEPILLOS

WJC251A0054001

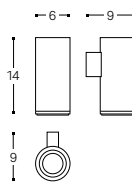

INCH 2.4x3.2x5.5



⊙△
FREE STANDING SOAP DISPENSER
DOSIFICADOR ENCIMERA

WJC251A0004001
200 ML

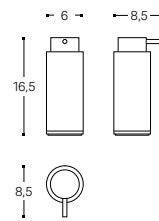

INCH 2.4x3.3x6.5



⊙△
SOAP DISPENSER
DOSIFICADOR

S WJC251A0005001
200 ML

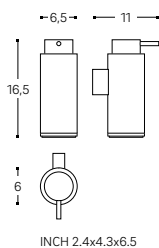

⊙△◇
FREE STANDING MAGNIFYING MIRROR
ESPEJO AUMENTO ENCIMERA

WJC251A0083051
(X3) CHROME-WHITE / CROMO-BLANCO

WJC251A0083061
(X3) CHROME-BLACK / CROMO-NEGRO

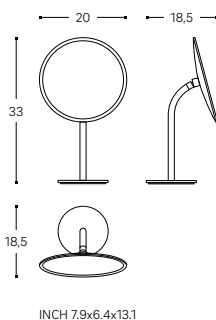

⊙△◇
WALL MAGNIFYING MIRROR
ESPEJO DE AUMENTO PARED

WJC251A0085051
(X3) CHROME-WHITE / CROMO-BLANCO

WJC251A0085061
(X3) CHROME-BLACK / CROMO-NEGRO

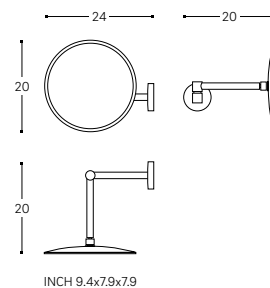

⊙◇
GLASS SHELF
ESTANTE VIDRIO

WJC251A0044001
40 CM / INCH 15.7

WJC251A0045001
60 CM / INCH 23.6

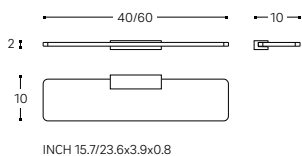

⊙△
SHOWER SOAP DISH *
JABONERA DE DUCHA *

S WJC251A0049051
CHROME-WHITE / CROMO-BLANCO

S WJC251A0049061
CHROME-BLACK / CROMO-NEGRO

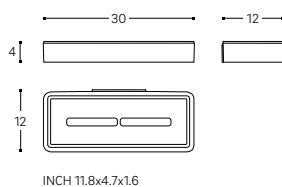

⊙△
CORNER SOAP DISH *
JABONERA DE DUCHA RINCÓN *

WJC251A0050051
CHROME-WHITE / CROMO-BLANCO

WJC251A0050061
CHROME-BLACK / CROMO-NEGRO

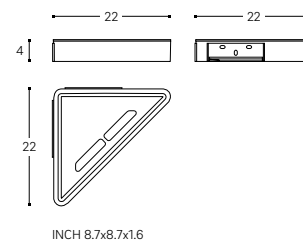

* CAN BE TAKEN APART FOR CLEANING.
* EXTRAÍBLES PARA SU LIMPIEZA.





TOWEL RACK
TOALLERO

WJC251A0062001

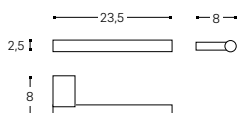

INCH 9.2x3.1x1



TOWEL RACK
TOALLERO

WJC251A0064001

40 CM / INCH 15.7

WJC251A0065001

60 CM / INCH 23.6

WJC251A0066001

80 CM / INCH 31.5

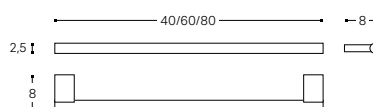

INCH 15.7/23.6/31.5x3.1x1



SWIVEL DOUBLE TOWEL RACK
TOALLERO DOBLE GIRATORIO

WJC251A0075001

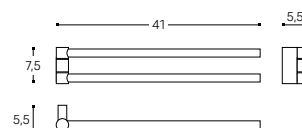

INCH 16.1x2.2x2.9



TOWEL RING
TOALLERO ARO

WJC251A0071001

15 CM / INCH 5.9

WJC251A0072001

20 CM / INCH 7.9

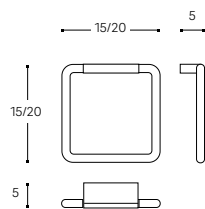

INCH 5.9/7.9x2x5.9/7.9



TOWEL RING
TOALLERO ARO

WJC251A0082001

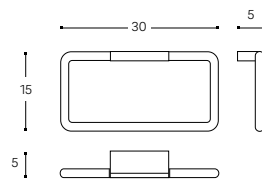

INCH 11.8x2x5.9



TOWEL RACK SHELF
TOALLERO ESTANTE

WJC251A0068001

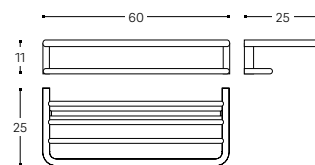

INCH 23.6x9.8x4.3



⊙
FREE STANDING TOWEL RACK
TOALLERO DE PIE

WJC251A0067001

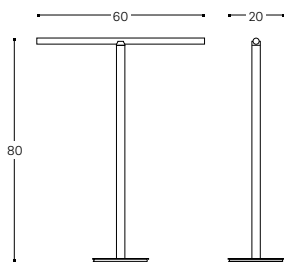

INCH 23.6x7.9x31.5



⊙
GRAB BAR
ASA BAÑERA

WJC251A0024001
40 CM / INCH 15.7
WJC251A0025001
60 CM / INCH 23.6
WJC251A0098001
80 CM / INCH 31.5
WJC251A0099001
100 CM / INCH 39.4

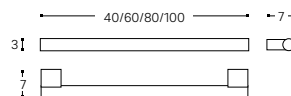

INCH 15.7/23.6/31.5/39.4x2.7x1.2



⊙△
PAPER HOLDER WITH COVER
PORTAPAPEL CON TAPA

WJC251A0059001

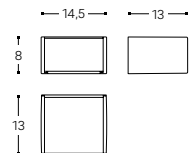

INCH 5.7x5.1x3.1



⊙
PAPER HOLDER WITHOUT COVER
PORTAPAPEL SIN TAPA

WJC251A0058001

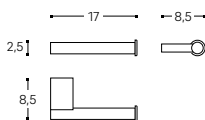

INCH 6.7x3.3x1



⊙
DOUBLE PAPER HOLDER WITHOUT COVER
PORTAPAPEL DOBLE SIN TAPA

WJC251A0057001

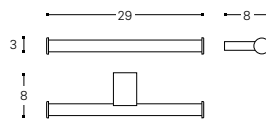

INCH 11.4x3.1x1.2



⊙△
VERTICAL PAPER HOLDER
PORTAPAPEL VERTICAL

WJC251A0096001

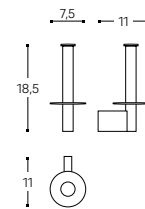

INCH 2.9x4.3x7.3





⊙○△
FREE-STANDING OR WALL TOILET BRUSH
ESCOBILLERO SUELO/PARED

WJC251A0000001

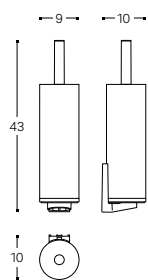

INCH 3.5x3.9x16.9



⊙○△
FREE STANDING TOILET BRUSH/PAPER HOLDER
ESCOBILLERO/PORTAPAPEL SUELO

WJC251A0097001

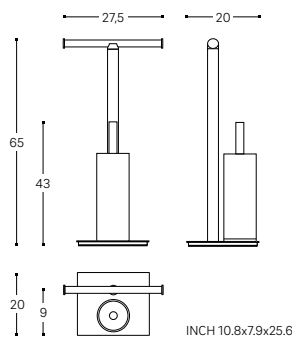

INCH 10.8x7.9x25.6



○
STOOL
TABURETE

WJC205A0006065
CHROME-MATTE WHITE / CROMO-BLANCO MATE
WJC205A0006036
CHROME-MATTE BLACK / CROMO-NEGRO MATE

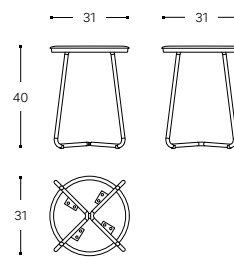

INCH 15.8x15.8x12.2



Stick

Design by **Valentí García**







Create a luminous space with accessories that can be installed with Quick-Fix adhesive tape, without drilling holes in the wall.

Crea un espacio luminoso con accesorios que se pueden instalar con cinta adhesiva Quick-Fix, sin taladrar la pared.









Decorate your bathroom with light accessories, an urban design that follows the trend in black.

Decora tu cuarto de baño con accesorios ligeros, de diseño urbano, que siguen la tendencia del color negro.





QUICK FIX / QUICK FIX

Our updated Stick collection now includes a dual installation system for installing bathroom accessories with or without a drill. Quick Fix adhesive, designed exclusively for our firm, means that bathroom accessories can be installed without drilling holes in the wall.

La colección Stick presenta como novedad el sistema de instalación dual, que permite sujetar los accesorios de baño con y sin taladros. Con el adhesivo Quick Fix, elaborado en exclusiva para la firma, se facilita el montaje sin la necesidad de hacer agujeros en la pared.

FEATURES / CARACTERÍSTICAS

Easy installation: double pitch screw. Hidden attachments. Anti-corrosion.

Fácil instalación: tornillo de doble paso. Fijaciones ocultas. Anticorrosión.

Stick has successfully passed the high demanding tests of long last durability and resistance to extreme uses (static charge or impact testing) to assure long last durability of the product. All products come with 10 years warranty.

Toda la gama Stick ha superado con éxito exigentes tests de durabilidad y resistencia a usos extremos (cargas estáticas o test de impacto), para asegurar una larga vida al producto. Todos los artículos tienen 10 años de garantía.



**QUICK
FIX**



Easy installation without drilling

Fácil instalación sin taladro



Bonded with high adhesion adhesive

Fijación con adhesivo de alta adherencia



Quick, easy, silent installation

Montaje sin ruido, fácil y rápido



Static load of 5 kg

Carga estática de 5 KG



Do not use on painted surfaces and gypsum walls

No usar en superficies pintadas ni en paredes rugosas





⊙
HOOK
COLGADOR

- S** **WJB276A0021001**
CHROME / CROMO
- S** **WJB276A0021065**
MATTE WHITE / BLANCO MATE
- S** **WJB276A0021036**
MATTE BLACK / NEGRO MATE

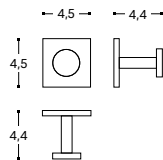

INCH 1.8x1.7x1.8



⊙
DOUBLE HOOK
COLGADOR DOBLE

- S** **WJB276A0022001**
CHROME / CROMO
- S** **WJB276A0022065**
MATTE WHITE / BLANCO MATE
- S** **WJB276A0022036**
MATTE BLACK / NEGRO MATE

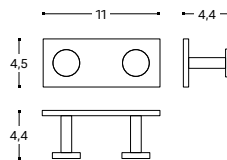

INCH 4.3x1.7x1.8



⊙
HOOK
COLGADOR

- S** **WJB276A0023001**
CHROME / CROMO
- S** **WJB276A0023065**
MATTE WHITE / BLANCO MATE
- S** **WJB276A0023036**
MATTE BLACK / NEGRO MATE

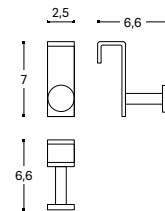

INCH 1x2.6x2.8



⊙
BRUSH-HOLDER
PORTACEPILLOS

- S** **WJB276A0053001**
CHROME / CROMO
- S** **WJB276A0053065**
MATTE WHITE / BLANCO MATE
- S** **WJB276A0053036**
MATTE BLACK / NEGRO MATE

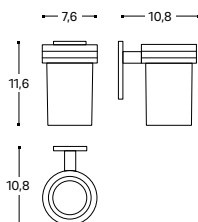

INCH 3x4.3x4.6



⊙
SOAP DISPENSER
DOSIFICADOR

- S** **WJB276A0003001**
200 ML CHROME / CROMO
- S** **WJB276A0003065**
200 ML MATTE WHITE / BLANCO MATE
- S** **WJB276A0003036**
200 ML MATTE BLACK / NEGRO MATE

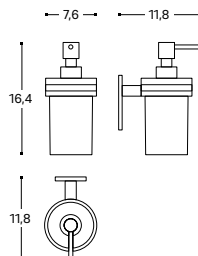

INCH 3x4.7x6.5



⊙
SOAP WIRE BASKET
JABONERA DE DUCHA

- S** **WJB276A0049001**
CHROME / CROMO
- S** **WJB276A0049065**
MATTE WHITE / BLANCO MATE
- S** **WJB276A0049036**
MATTE BLACK / NEGRO MATE

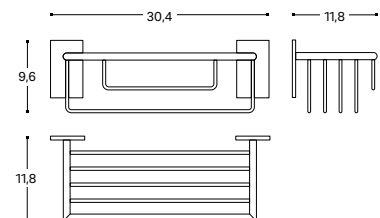

INCH 12x4.7x3.8





TOWEL RING
TOALLERO ARO

- WJB276A0071001**
CHROME / CROMO
- WJB276A0071065**
MATTE WHITE / BLANCO MATE
- WJB276A0071036**
MATTE BLACK / NEGRO MATE

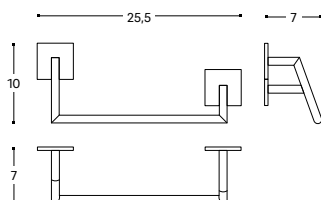

INCH 10x3.9x2.8



TOWEL RACK
TOALLERO

- WJB276A0063001**
30 CM / INCH 11.8 CHROME / CROMO
- WJB276A0064001**
45 CM / INCH 17.7 CHROME / CROMO
- WJB276A0065001**
60 CM / INCH 23.6 CHROME / CROMO
- WJB276A0063065**
30 CM / INCH 11.8 MATTE WHITE / BLANCO MATE
- WJB276A0064065**
45 CM / INCH 17.7 MATTE WHITE / BLANCO MATE
- WJB276A0065065**
60 CM / INCH 23.6 MATTE WHITE / BLANCO MATE
- WJB276A0063036**
30 CM / INCH 11.8 MATTE BLACK / NEGRO MATE
- WJB276A0064036**
45 CM / INCH 17.7 MATTE BLACK / NEGRO MATE
- WJB276A0065036**
60 CM / INCH 23.6 MATTE BLACK / NEGRO MATE

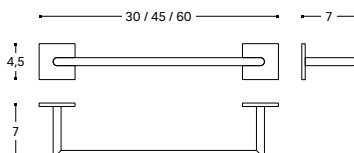

INCH 11.8/17.7/23.6x2.8x1.8



TOWEL RACK
TOALLERO

- WJB276A0066001**
28 CM / INCH 11 CHROME / CROMO
- WJB276A0067001**
38 CM / INCH 15 CHROME / CROMO
- WJB276A0066065**
28 CM / INCH 11 MATTE WHITE / BLANCO MATE
- WJB276A0067065**
38 CM / INCH 15 MATTE WHITE / BLANCO MATE
- WJB276A0066036**
28 CM / INCH 11 MATTE BLACK / NEGRO MATE
- WJB276A0067036**
38 CM / INCH 15 MATTE BLACK / NEGRO MATE

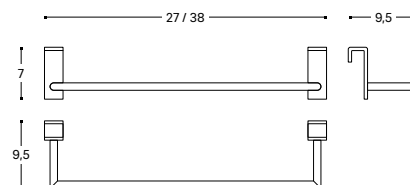

INCH 11/15x2.8x3.7



PAPER HOLDER WITH COVER
PORTAPEPEL CON TAPA

- WJB276A0044001**
CHROME / CROMO
- WJB276A0044065**
MATTE WHITE / BLANCO MATE
- WJB276A0044036**
MATTE BLACK / NEGRO MATE

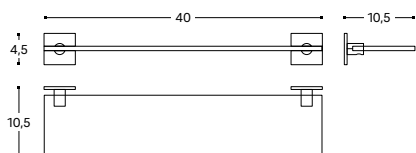

INCH 15.8x4.1x1.8

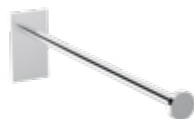

TOWEL RACK
TOALLERO

- WJB276A0069001**
CHROME / CROMO
- WJB276A0069065**
MATTE WHITE / BLANCO MATE
- WJB276A0069036**
MATTE BLACK / NEGRO MATE

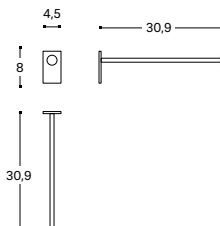

INCH 1.8x12.2x3.2



PAPER HOLDER WITHOUT COVER
PORTAPEPEL SIN TAPA

- WJB276A0058001**
CHROME / CROMO
- WJB276A0058065**
MATTE WHITE / BLANCO MATE
- WJB276A0058036**
MATTE BLACK / NEGRO MATE

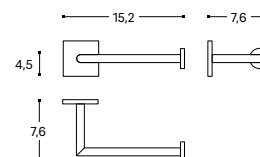

INCH 6x3x1.8



⊙○
PAPER HOLDER WITH COVER
PORTAPAPEL CON TAPA

WJB276A0059001
CHROME / CROMO

WJB276A0059065
MATTE WHITE / BLANCO MATE

WJB276A0059036
MATTE BLACK / NEGRO MATE

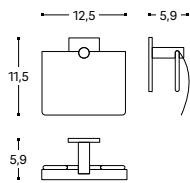

INCH 4.9x2.3x4.5



⊙
PAPER HOLDER WITHOUT COVER
PORTAPAPEL SIN TAPA

WJB276A0096001
CHROME / CROMO

WJB276A0096065
MATTE WHITE / BLANCO MATE

WJB276A0096036
MATTE BLACK / NEGRO MATE

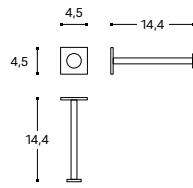

INCH 1.8x5.7x1.8



⊙⊙
TOILET BRUSH
ESCOBILLERO

Ⓢ **WJB276A0001001**
CHROME / CROMO

Ⓢ **WJB276A0001065**
MATTE WHITE / BLANCO MATE

Ⓢ **WJB276A0001036**
MATTE BLACK / NEGRO MATE

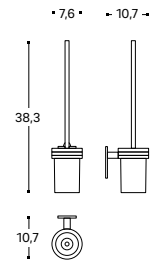

INCH 3x4.2x15.1



The Grid

Design by Ricard Ferrer





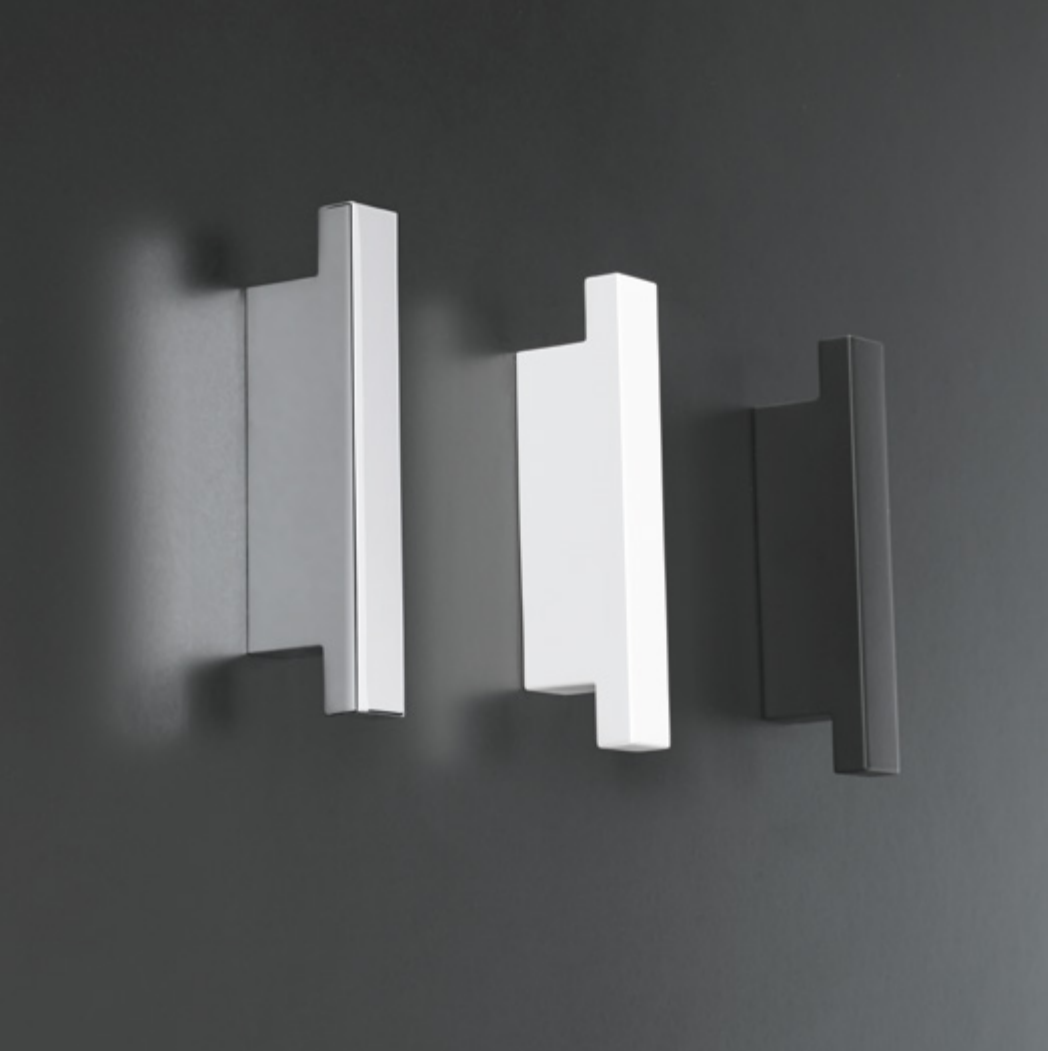

Parallel lines which frame
objects specifically designed
for an architecturally
engineered bathroom.

Líneas paralelas que
enmarcan objetos dedicados
a un baño concebido desde
la óptica arquitectónica.





The Grid

Design by Ricard Ferrer



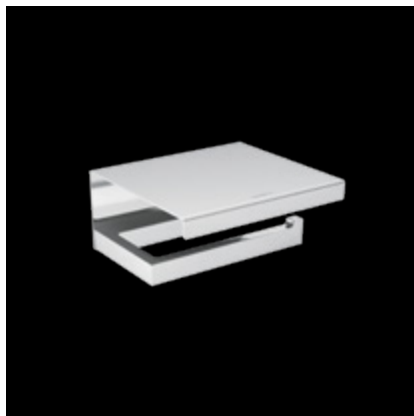
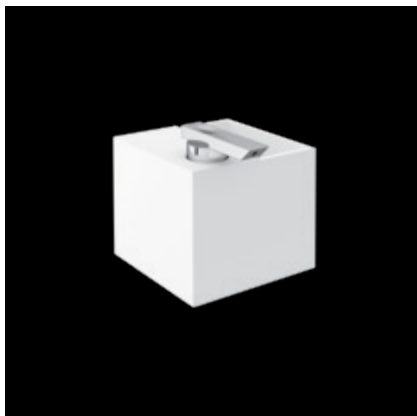

FEATURES / CARACTERÍSTICAS

Hidden attachments. Anti-Corrosion.
Lead free matte paint. Shelves & glasses
made of acrylic glass.

Fijaciones ocultas. Anticorrosión.
Pintura mate libre de plomo. Estantes
y vasos fabricados en cristal acrílico.

Accessories with a ground-breaking,
functional design. A commitment to
innovation and modernity.

Accesorios con un diseño rompedor
y funcional. Una apuesta por la innovación
y la modernidad.

The Grid has successfully passed
the high demanding tests of long last
durability and resistance to extreme
uses (static charge or impact testing)
to assure long last durability of the
product.

Toda la gama **The Grid** ha superado
con éxito exigentes tests de durabilidad
y resistencia a usos extremos (cargas
estáticas o test de impacto), para
asegurar una larga vida al producto.

STRUCTURE FINISHES / ACABADOS ESTRUCTURA



001
Chrome
Cromo

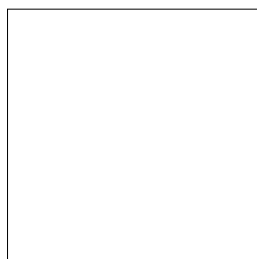

065
Matte white
Blanco mate

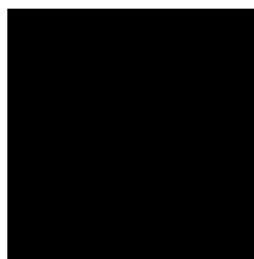

036
Matte black
Negro mate

SHELF/FURNITURE FINISHES / ACABADOS ESTANTES/MUEBLES

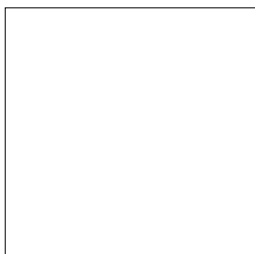

Matte white
Blanco mate

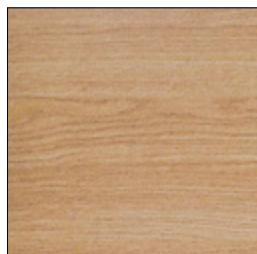

Clear oak
Roble claro

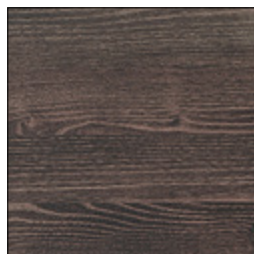

Dark oak
Roble oscuro



The Grid

Design by Ricard Ferrer



⊙
HOOK
COLGADOR

- Ⓢ **WJC268A0021001**
CHROME / CROMO
- Ⓢ **WJC268A0021036**
MATTE BLACK / NEGRO MATE
- Ⓢ **WJC268A0021065**
MATTE WHITE / BLANCO MATE



INCH 0.6x1.2x4.3



⊙△
FREE-STANDING SOAP DISPENSER + BRUSH-HOLDER
DOSIFICADOR + PORTACEPILLOS ENCIMERA

- WJC268A0004001**
385 ML CHROME / CROMO
- WJC268A0004036**
385 ML MATTE BLACK / NEGRO MATE
- WJC268A0004065**
385 ML MATTE WHITE / BLANCO MATE

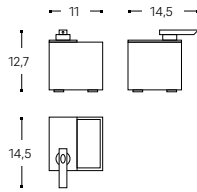

INCH 4.3x5.7x5



⊙△
SOAP DISPENSER + BRUSH-HOLDER
DOSIFICADOR + PORTACEPILLOS

- WJC268A0005001**
385 ML CHROME / CROMO
- WJC268A0005036**
385 ML MATTE BLACK / NEGRO MATE
- WJC268A0005065**
385 ML MATTE WHITE / BLANCO MATE

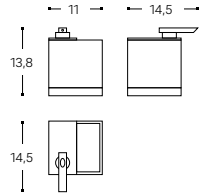

INCH 4.3x5.7x5.4



△
DOUBLE BRUSH-HOLDER
PORTACEPILLOS DOBLE

WJC268A0053065

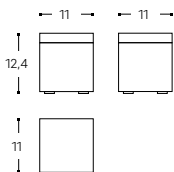

INCH 4.3x4.3x4.9



⊙△
TOWEL RACK WITH SHELF / BASKET
TOALLERO CON REPISA / CONTAINER

- Ⓢ **WJC268A0063001**
CHROME / CROMO
- Ⓢ **WJC268A0063036**
MATTE BLACK / NEGRO MATE
- Ⓢ **WJC268A0063065**
MATTE WHITE / BLANCO MATE

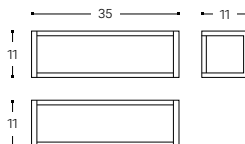

INCH 13.8x4.3x4.3



⊙△
TOWEL RACK WITH SHELF / BASKET
TOALLERO CON REPISA / CONTAINER

- Ⓢ **WJC268A0065001**
CHROME / CROMO
- Ⓢ **WJC268A0065036**
MATTE BLACK / NEGRO MATE
- WJC268A0065065**
MATTE WHITE / BLANCO MATE

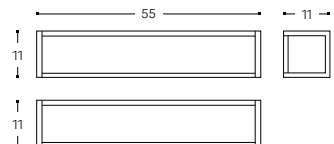

INCH 21.7x4.3x4.3





TOWEL RING
TOALLERO ARO

- WJC268A0071001**
CHROME / CROMO
- WJC268A0071036**
MATTE BLACK / NEGRO MATE
- WJC268A0071065**
MATTE WHITE / BLANCO MATE

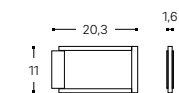

INCH 9.2x0.6x4.3



SWIVEL TOWEL RACK
TOALLERO GIRATORIO

- WJC268A0074001**
CHROME / CROMO
- WJC268A0074036**
MATTE BLACK / NEGRO MATE
- WJC268A0074065**
MATTE WHITE / BLANCO MATE

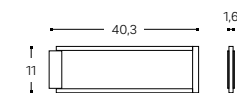

INCH 15.9x0.6x4.3



TOWEL RACK SHELF
TOALLERO ESTANTE

- WJC268A0068001**
CHROME / CROMO
- WJC268A0068036**
MATTE BLACK / NEGRO MATE
- WJC268A0068065**
MATTE WHITE / BLANCO MATE

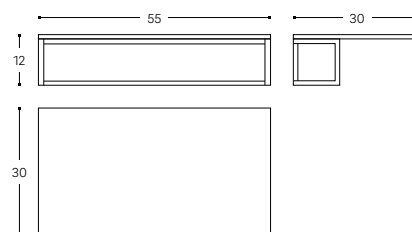

INCH 21.7x11.8x4.7



PAPER HOLDER WITH COVER
PORTAPEPEL CON TAPA

- WJC268A0059001**
CHROME / CROMO
- WJC268A0059036**
MATTE BLACK / NEGRO MATE
- WJC268A0059065**
MATTE WHITE / BLANCO MATE

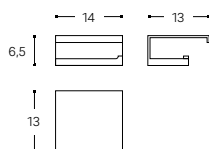

INCH 5.5x5.1x2.6



PAPER HOLDER WITHOUT COVER
PORTAPEPEL SIN TAPA

- WJC268A0058001**
CHROME / CROMO
- WJC268A0058036**
MATTE BLACK / NEGRO MATE
- WJC268A0058065**
MATTE WHITE / BLANCO MATE

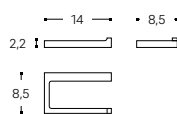

INCH 5.5x3.3x0.9



FREE-STANDING OR WALL TOILET BRUSH
ESCOBILLERO SUELO/PARED

- WJC268A0000001**
CHROME / CROMO
- WJC268A0000036**
MATTE BLACK / NEGRO MATE
- WJC268A0000065**
MATTE WHITE / BLANCO MATE

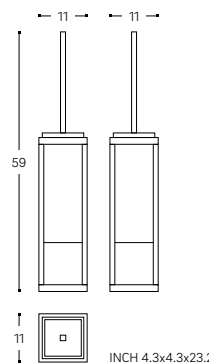

INCH 4.3x4.3x23.2

The Grid

Design by Ricard Ferrer



⊙ ▲
TOILET BRUSH
ESCOBILLERO

- WJC268A0001001**
CHROME / CROMO
- WJC268A0001036**
MATTE BLACK / NEGRO MATE
- WJC268A0001065**
MATTE WHITE / BLANCO MATE

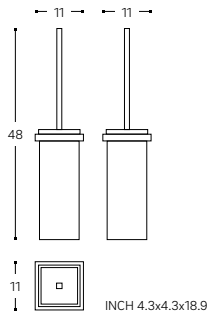

⊙ ▲
PORTABLE TOILET BRUSH + PAPER HOLDER + WASTE BIN
PORTÁTIL ESCOBILLERO + PORTAPEPEL + PAPELERA

- WJC268A0518653**
CHROME-MATTE WHITE / CROMO-BLANCO MATE
- WJC268A0518654**
MATTE BLACK-MATTE WHITE / NEGRO MATE-BLANCO MATE
- WJC268A0518655**
MATTE WHITE-MATTE WHITE / BLANCO MATE-BLANCO MATE

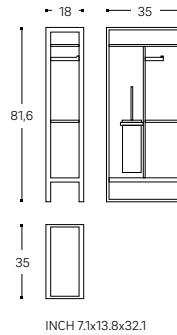

⊙ □ ▲
FREE STANDING TOWEL RACK
TOALLERO DE PIE

- WJC268A0517642**
CHROME-CLEAR OAK / CROMO-ROBLE CLARO
- WJC268A0517634**
CHROME-DARK OAK / CROMO-ROBLE OSCURO
- WJC268A0517653**
CHROME-MATTE WHITE / CROMO-BLANCO MATE
- WJC268A0517641**
MATTE BLACK-CLEAR OAK / NEGRO MATE-ROBLE CLARO
- WJC268A0517632**
MATTE BLACK-DARK OAK / NEGRO MATE-ROBLE OSCURO
- WJC268A0517654**
MATTE BLACK-MATTE WHITE / NEGRO MATE-BLANCO MATE
- WJC268A0517639**
MATTE WHITE-CLEAR OAK / BLANCO MATE-ROBLE CLARO
- WJC268A0517633**
MATTE WHITE-DARK OAK / BLANCO MATE-ROBLE OSCURO
- WJC268A0517655**
MATTE WHITE-MATTE WHITE / BLANCO MATE-BLANCO MATE

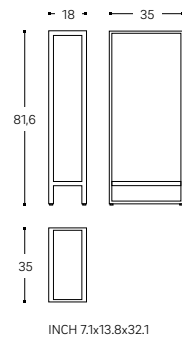



○ □ ▲
STOOL
TABURETE

- ■ **WJC268A0616642**
CHROME-CLEAR OAK / CROMO-ROBLE CLARO
- ■ **WJC268A0616634**
CHROME-DARK OAK / CROMO-ROBLE OSCURO
- □ **WJC268A0616653**
CHROME-MATTE WHITE / CROMO-BLANCO MATE
- ■ **WJC268A0616641**
MATTE BLACK-CLEAR OAK / NEGRO MATE-ROBLE CLARO
- ■ **WJC268A0616632**
MATTE BLACK-DARK OAK / NEGRO MATE-ROBLE OSCURO
- □ **WJC268A0616654**
MATTE BLACK-MATTE WHITE / NEGRO MATE-BLANCO MATE
- ■ **WJC268A0616639**
MATTE WHITE-CLEAR OAK / BLANCO MATE-ROBLE CLARO
- ■ **WJC268A0616633**
MATTE WHITE-DARK OAK / BLANCO MATE-ROBLE OSCURO
- □ **WJC268A0616655**
MATTE WHITE-MATTE WHITE / BLANCO MATE-BLANCO MATE

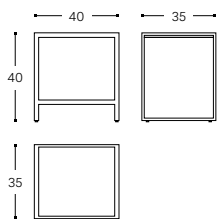

INCH 15.8x13.8x16.5

Urban

Design by **Cosmic Studio**







La semplicità grafica dietro il suo design elegante. Con finiture in vetro e cromato, Urban è già un'emblema.

A graphic severity underlines this elegant design; Finished in glass and chrome, urban is a statement piece.













Urban has successfully passed the high demanding tests of long last durability and resistance to extreme uses (static charge or impact testing) to assure long last durability of the product.

Toda la gama **Urban** ha superado con éxito exigentes tests de durabilidad y resistencia a usos extremos (cargas estáticas o test de impacto), para asegurar una larga vida al producto.



FEATURES / CARACTERÍSTICAS

Easy installation: double pitch screw.
Hidden attachments. Anti-corrosion.

Fácil instalación: tornillo de doble paso.
Fijaciones ocultas. Anticorrosión.

FINISHES / ACABADOS



767
Chrome-Black Glass
Cromo-Cristal Negro



001
Chrome-Transparent Glass
Cromo-Cristal Transparente



⊙
HOOK
COLGADOR

Ⓢ **WJP049A3001001**
CHROME / CROMO

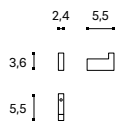

INCH 7.9x5x3.1



⊙
TOWEL RACK
TOALLERO

Ⓢ **WJP049A1060001**
60 CM CHROME / CROMO
Ⓢ **WJP049A1040001**
40 CM CHROME / CROMO
Ⓢ **WJP049A1030001**
30 CM CHROME / CROMO

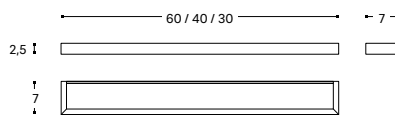

INCH 23.6/15.7/11.8x2.8x1



⊙
TOWEL RING
TOALLERO ARO

WJP049A2055001
CHROME / CROMO

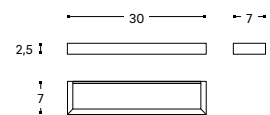

INCH 4.9x3.9x16.9



⊙
DOUBLE LATERAL TOWEL RACK
TOALLERO LATERAL DOBLE

WJP049A1401001
CHROME / CROMO

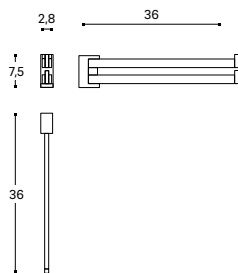

INCH 3.8x3.3x15.5



⊙
TOWEL RACK SHELF
TOALLERO ESTANTE

WJP049A5110001
CHROME / CROMO

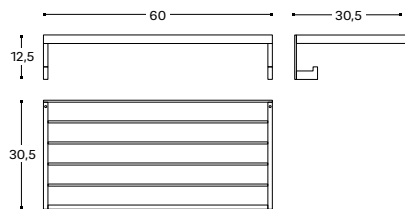

INCH 4.9x3.3x16.9



⊙
SHELF
ESTANTE

WJP049A5040767
CHROME-BLACK GLASS / CROMO-CRISTAL NEGRO
WJP049A5040001
CHROME-TRANSPARENT GLASS / CROMO-CRISTAL TRANSPARENTE

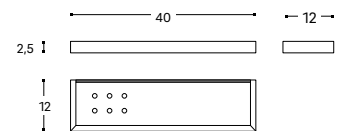

INCH 3.8x2.6x15.5





⊙
SOAP WIRE BASKET
JABONERA DE DUCHA

WJP049A6020001
CHROME / CROMO

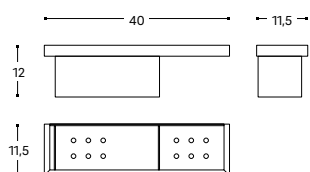

INCH 3.7x3.1x5.7



⊙
RIGHT PAPER HOLDER WITHOUT COVER
PORTAPEPEL SIN TAPA DERECHO

WJP049A4001001
CHROME / CROMO

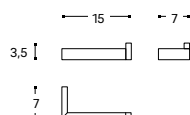

INCH 3.8x2.6x4.3



⊙
LEFT PAPER HOLDER WITHOUT COVER
PORTAPEPEL SIN TAPA IZQUIERDO

WJP049A4010001
CHROME / CROMO

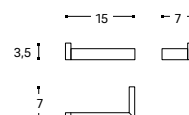

INCH 2.8x4.3x8.5



⊙
PAPER HOLDER WITH COVER
PORTAPEPEL CON TAPA

WJP049A4002001
CHROME / CROMO

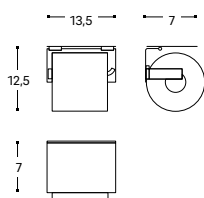

INCH 3.1x3.9x7.5



⊙⊙△
TOILET BRUSH
ESCOBILLERO

WJP049A9001001
CHROME / CROMO

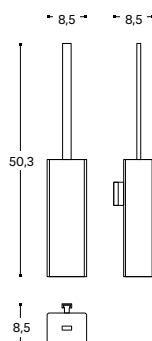

INCH 7.7x4.5x2



⊙⊙△
FREE STANDING TOILET BRUSH
ESCOBILLERO SUELO

WJP049A9050001
CHROME / CROMO

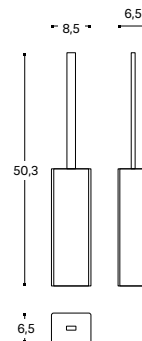

INCH 8.1x4.2x2.4



⊙△
BRUSH-HOLDER
 PORTACEPILLOS

WJP049A7001001
 CHROME / CROMO

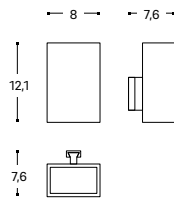

INCH 7.9x5x3.1



⊙△
SOAP DISPENSER
 DOSIFICADOR

WJP049A7801001
 250 ML CHROME / CROMO

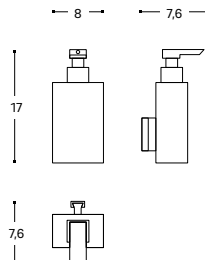

INCH 7.9x5x3.1



◆⊙
SOAP DISH
 JABONERA

WJP049A6001767
 CHROME-BLACK GLASS / CROMO-CRISTAL NEGRO
WJP049A6001001
 CHROME-TRANSPARENT GLASS / CROMO-CRISTAL TRANSPARENTE

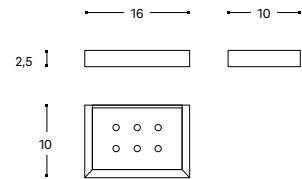

INCH 4.9x3.9x16.9



⊙△
FREE STANDING BRUSH-HOLDER
 PORTACEPILLOS ENCIMERA

WJP049A7050001
 CHROME / CROMO

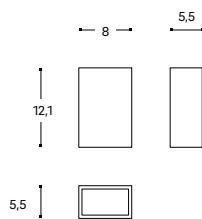

INCH 3.8x3.3x15.5



⊙
FREE STANDING SOAP DISPENSER
 DOSIFICADOR ENCIMERA

WJP049A7831001
 250 ML CHROME / CROMO

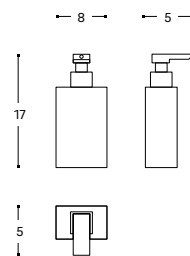

INCH 4.9x3.3x16.9



◆⊙
FREE STANDING SOAP DISH
 JABONERA ENCIMERA

WJP049A6050767
 CHROME-BLACK GLASS / CROMO-CRISTAL NEGRO
WJP049A6050001
 CHROME-TRANSPARENT GLASS / CROMO-CRISTAL TRANSPARENTE

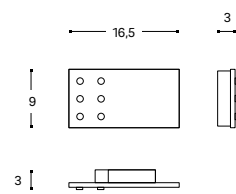

INCH 3.8x2.6x15.5





Windsor

Design by **Cosmic Studio**





Its archetypal design combined with the warm toned finishes make for a modern classic.

Sus trazos clásicos combinados con acabados cálidos la convierten en una pieza atemporal.











10
YEARS GUARANTEE
AÑOS GARANTÍA
COSMIC

3
YEARS GUARANTEE
AÑOS GARANTÍA
GOLD



Windsor has successfully passed the high demanding tests of long last durability and resistance to extreme uses (static charge or impact testing) to assure long last durability of the product.

Toda la gama **Windsor** ha superado con éxito exigentes tests de durabilidad y resistencia a usos extremos (cargas estáticas o test de impacto), para asegurar una larga vida al producto.

FEATURES / CARACTERÍSTICAS

Hidden attachments.
Anti-corrosion.

Fijaciones ocultas.
Anticorrosión.

FINISHES / ACABADOS



004
Gold
Oro



001
Chrome
Cromo



014
White-Chrome
Blanco-Cromo



011
Old Brass
Latón viejo



⊙
HOOK
COLGADOR

- WJP026A3001004**
GOLD / ORO
- WJP026A3001001**
CHROME / CROMO
- WJP026A3001014**
CHROME-GOLD / CROMO-ORO
- WJP026A3001011**
OLD BRASS / LATÓN VIEJO

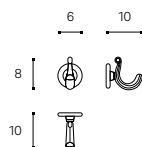

INCH 2.4x3.9x3.1



⊙
DOUBLE HOOK
COLGADOR DOBLE

- WJP026A3002004**
GOLD / ORO
- WJP026A3002001**
CHROME / CROMO
- WJP026A3002014**
CHROME-GOLD / CROMO-ORO
- WJP026A3002011**
OLD BRASS / LATÓN VIEJO

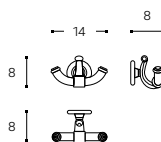

INCH 5.5x3.1x3.1



⊙◆
FREE STANDING SOAP DISH
JABONERA ENCIMERA

- WJP026A6090004**
GOLD / ORO
- WJP026A6090001**
CHROME / CROMO
- WJP026A6090014**
CHROME-GOLD / CROMO-ORO
- WJP026A6090011**
OLD BRASS / LATÓN VIEJO

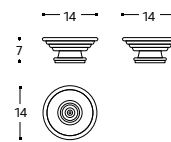

INCH 5.5x5.5x2.8



⊙◆
SOAP DISH
JABONERA

- WJP026A6001004**
GOLD / ORO
- WJP026A6001001**
CHROME / CROMO
- WJP026A6001014**
CHROME-GOLD / CROMO-ORO
- WJP026A6001011**
OLD BRASS / LATÓN VIEJO

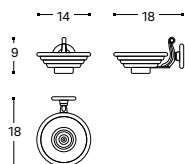

INCH 5.5x7.1x3.5



⊙△
FREE STANDING BRUSH-HOLDER
PORTACEPILLOS ENCIMERA

- WJP026A7052004**
GOLD / ORO
- WJP026A7052001**
CHROME / CROMO
- WJP026A7052014**
CHROME-GOLD / CROMO-ORO
- WJP026A7052011**
OLD BRASS / LATÓN VIEJO

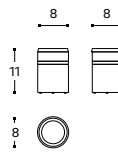

INCH 3.1x3.1x4.3



⊙◆
BRUSH-HOLDER
PORTACEPILLOS

- WJP026A7002004**
GOLD / ORO
- WJP026A7002001**
CHROME / CROMO
- WJP026A7002014**
CHROME-GOLD / CROMO-ORO
- WJP026A7002011**
OLD BRASS / LATÓN VIEJO

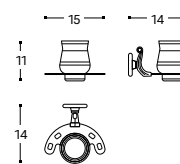

INCH 5.9x5.5x4.3





FREE STANDING SOAP DISPENSER
DOSIFICADOR ENCIMERA

- WJP026A7833004**
175 ML GOLD / ORO
- WJP026A7833001**
175 ML CHROME / CROMO
- WJP026A7833014**
175 ML CHROME-GOLD / CROMO-ORO
- WJP026A7833011**
175 ML OLD BRASS / LATÓN VIEJO



INCH 2.4x2.4x6.7



SOAP DISPENSER
DOSIFICADOR

- WJP026A7801004**
200 ML GOLD / ORO
- WJP026A7801001**
200 ML CHROME / CROMO
- WJP026A7801014**
200 ML CHROME-GOLD / CROMO-ORO
- WJP026A7801011**
200 ML OLD BRASS / LATÓN VIEJO

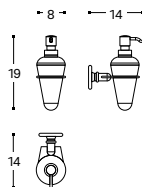

INCH 3.1x5.5x7.5



TISSUE BOX
CAJA KLEENEX

- WJP026A9401004**
GOLD / ORO
- WJP026A9401001**
CHROME / CROMO
- WJP026A9401014**
CHROME-GOLD / CROMO-ORO
- WJP026A9401011**
OLD BRASS / LATÓN VIEJO

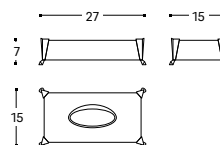

INCH 10.6x5.9x2.8



FREE STANDING MAGNIFYING MIRROR (X5)
ESPEJO AUMENTO ENCIMERA (X5)

- WJP026A8104004**
GOLD / ORO
- WJP026A8104001**
CHROME / CROMO
- WJP026A8104014**
CHROME-GOLD / CROMO-ORO
- WJP026A8104011**
OLD BRASS / LATÓN VIEJO

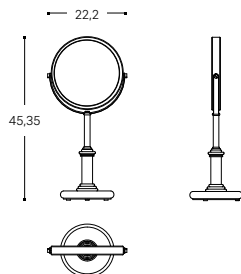

INCH 9.1x9.1x18.1



SHELF
ESTANTE

- WJP026A5060004**
GOLD / ORO
- WJP026A5060001**
CHROME / CROMO
- WJP026A5060014**
CHROME-GOLD / CROMO-ORO
- WJP026A5060011**
OLD BRASS / LATÓN VIEJO

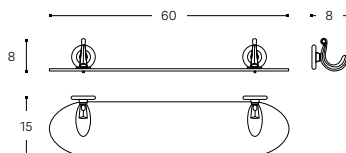

INCH 19.7x3.9x0.8



TOWEL RACK SHELF
TOALLERO ESTANTE

- WJP026A5110004**
GOLD / ORO
- WJP026A5110001**
CHROME / CROMO
- WJP026A5110014**
CHROME-GOLD / CROMO-ORO
- WJP026A5110011**
OLD BRASS / LATÓN VIEJO

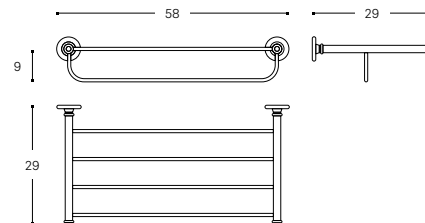

INCH 22.8x11.4x3.5





TOWEL RACK
TOALLERO

- WJP026A1040004**
40 CM GOLD / ORO
- WJP026A1040001**
40 CM CHROME / CROMO
- WJP026A1040014**
40 CM CHROME-GOLD / CROMO-ORO
- WJP026A1040011**
40 CM OLD BRASS / LATÓN VIEJO

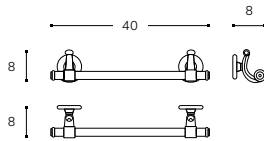

INCH 15.7x3.1x1.6



TOWEL RACK
TOALLERO

- WJP026A1050004**
50 CM GOLD / ORO
- WJP026A1050001**
50 CM CHROME / CROMO
- WJP026A1050014**
50 CM CHROME-GOLD / CROMO-ORO
- WJP026A1050011**
50 CM OLD BRASS / LATÓN VIEJO

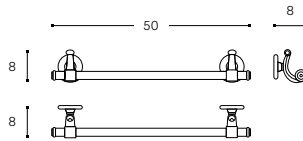

INCH 19.7x3.1x1.6



TOWEL RACK
TOALLERO

- WJP026A1060004**
60 CM GOLD / ORO
- WJP026A1060001**
60 CM CHROME / CROMO
- WJP026A1060014**
60 CM CHROME-GOLD / CROMO-ORO
- WJP026A1060011**
60 CM OLD BRASS / LATÓN VIEJO

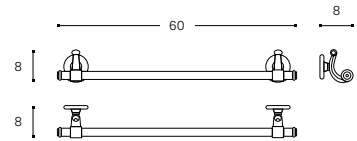

INCH 23.6x3.1x1.6



TOWEL RING
TOALLERO ARO

- WJP026A2055004**
GOLD / ORO
- WJP026A2055001**
CHROME / CROMO
- WJP026A2055014**
CHROME-GOLD / CROMO-ORO
- WJP026A2055011**
OLD BRASS / LATÓN VIEJO

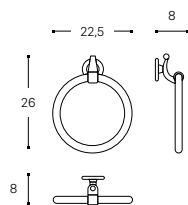

INCH 8.9x3.1x10.2



PAPER HOLDER WITH COVER
PORTAPAPEL CON TAPA

- WJP026A4091004**
GOLD / ORO
- WJP026A4091001**
CHROME / CROMO
- WJP026A4091014**
CHROME-GOLD / CROMO-ORO
- WJP026A4091011**
OLD BRASS / LATÓN VIEJO

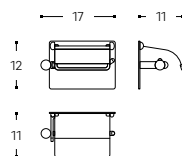

INCH 6.7x4.3x4.7



PAPER HOLDER WITHOUT COVER
PORTAPAPEL SIN TAPA

- WJP026A1481004**
GOLD / ORO
- WJP026A1481001**
CHROME / CROMO
- WJP026A1481014**
CHROME-GOLD / CROMO-ORO
- WJP026A1481011**
OLD BRASS / LATÓN VIEJO

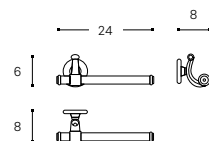

INCH 9.4x3.1x2.4





FREE STANDING TOILET BRUSH
ESCOBILLERO SUELO

WJP026A9050004
GOLD / ORO

WJP026A9050001
CHROME / CROMO

WJP026A9050014
CHROME-GOLD / CROMO-ORO

WJP026A9050011
OLD BRASS / LATÓN VIEJO

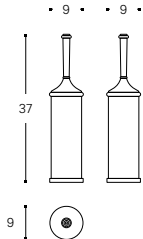

INCH 3.5x3.5x14.6



TOILET BRUSH
ESCOBILLERO

WJP026A9001004
GOLD / ORO

WJP026A9001001
CHROME / CROMO

WJP026A9001014
CHROME-GOLD / CROMO-ORO

WJP026A9001011
OLD BRASS / LATÓN VIEJO

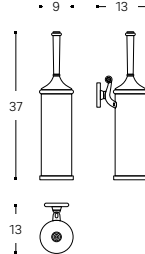

INCH 3.5x5.1x14.6



FREE STANDING TOWEL RACK
TOALLERO DE PIE

WJP026A1201004
GOLD / ORO

WJP026A1201001
CHROME / CROMO

WJP026A1201014
CHROME-GOLD / CROMO-ORO

WJP026A1201011
OLD BRASS / LATÓN VIEJO

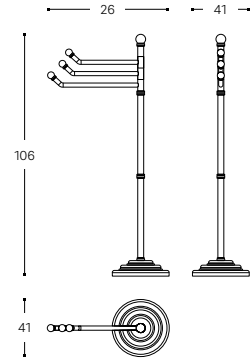

INCH 10.2x16.1x41.7



WASTE BIN
PAPELERA

WJP026A9301004
GOLD / ORO

WJP026A9301001
CHROME / CROMO

WJP026A9301014
CHROME-GOLD / CROMO-ORO

WJP026A0030000
OLD BRASS / LATÓN VIEJO

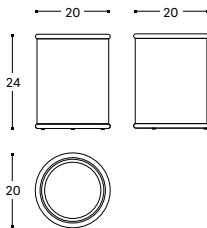

INCH 7.9x3.9x9.5



WASTE BIN
PAPELERA

WJP026A9350004
GOLD / ORO

WJP026A9350001
CHROME / CROMO

WJP026A9350014
CHROME-GOLD / CROMO-ORO

WJP026A9350011
OLD BRASS / LATÓN VIEJO

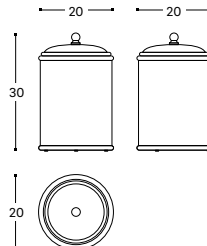

INCH 7.9x3.9x11.8



TISSUE BOX
CAJA KLEENEX

WJP016A9401004
26 CM GOLD / ORO

WJP016A9401001
26 CM CHROME / CROMO

WJP016A9401014
26 CM CHROME-GOLD / CROMO-ORO

WJP016A9447001
13 CM CHROME / CROMO

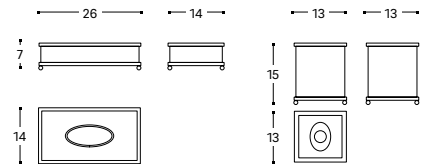

INCH 5.5x7.1x3.5

INCH 5.1x5.1x5.9



Geyser

Design by Nahtrang







Shapes that flow like water for an accessory line designed for today's bathroom.

Formas que fluyen como el agua para una línea de complementos pensada para el cuarto de baño actual.



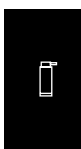





Geyser has successfully passed the high demanding tests of long last durability and resistance to extreme uses (static charge or impact testing) to assure long last durability of the product.

Toda la gama **Geyser** ha superado con éxito exigentes tests de durabilidad y resistencia a usos extremos (cargas estáticas o test de impacto), para asegurar una larga vida al producto.



FEATURES / CARACTERÍSTICAS

Accessories manufactured with stainless steel coated with matte paint. Wall-mounted pieces (hooks and paper holder) are made of Zamak coated with matte paint. Also available in chrome finish. Easy installation: double pitch screw. Hidden attachments. Anti-corrosion.

Complementos fabricados en acero inoxidable recubierto de una pintura mate. Las piezas con fijación a pared (colgador y portapapel sin tapa) están fabricadas en Zamak recubierto de pintura mate. Disponibles también en acabado cromo. Fácil instalación: tornillo de doble paso. Fijaciones ocultas. Anticorrosión.

FINISHES / ACABADOS



065
Matte white
Blanco mate



036
Matte black
Negro mate



086
Matte sage green
Verde salvia mate



087
Matte stone
Piedra mate



001
Chrome
Cromo



⊙
HOOK
COLGADOR

- WJC277A0021065**
WHITE / BLANCO
- WJC277A0021036**
BLACK / NEGRO
- WJC277A0021086**
SAGE GREEN / VERDE SALVIA
- WJC277A0021087**
STONE / PIEDRA
- WJC277A0021001**
CHROME / CROMO

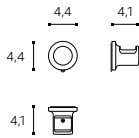

INCH 1.7x1.6x1.7



○△
FREE STANDING BRUSH-HOLDER
PORTACEPILLOS ENCIMERA

- WJC277A0051065**
WHITE / BLANCO
- WJC277A0051036**
BLACK / NEGRO
- WJC277A0051086**
SAGE GREEN / VERDE SALVIA
- WJC277A0051087**
STONE / PIEDRA

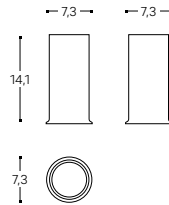

INCH 2.9x2.9x5.5



NEW
185 ML

○
FREE STANDING SOAP DISPENSER
DOSIFICADOR ENCIMERA

- WJC277A0004065**
185 ML WHITE / BLANCO
- WJC277A0004036**
185 ML BLACK / NEGRO
- WJC277A0004086**
185 ML SAGE GREEN / VERDE SALVIA
- WJC277A0004087**
185 ML STONE / PIEDRA

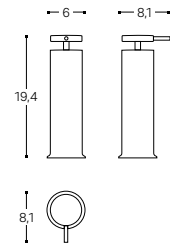

INCH 2.4x3.2x7.6



○
FREE STANDING SOAP DISH
JABONERA ENCIMERA

- WJC277A0032065**
WHITE / BLANCO
- WJC277A0032036**
BLACK / NEGRO
- WJC277A0032086**
SAGE GREEN / VERDE SALVIA
- WJC277A0032087**
STONE / PIEDRA

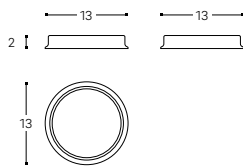

INCH 5.1x5.1x0.8



○◇
FREE STANDING MAGNIFYING MIRROR (X5)
ESPEJO AUMENTO ENCIMERA (X5)

- WJC277A0084065**
WHITE / BLANCO
- WJC277A0084036**
BLACK / NEGRO
- WJC277A0084086**
SAGE GREEN / VERDE SALVIA
- WJC277A0084087**
STONE / PIEDRA

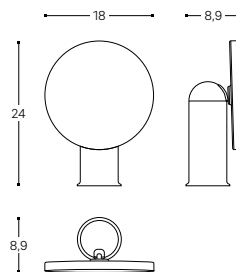

INCH 7.1x3.5x9.5



⊙
PAPER HOLDER WITHOUT COVER
PORTAPEPSEL SIN TAPA

- WJC277A0058065**
WHITE / BLANCO
- WJC277A0058036**
BLACK / NEGRO
- WJC277A0058086**
SAGE GREEN / VERDE SALVIA
- WJC277A0058087**
STONE / PIEDRA
- WJC277A0058001**
CHROME / CROMO

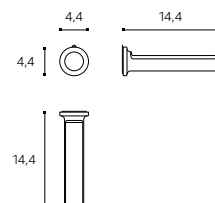

INCH 1.7x5.7x1.7





FLOOR TOILET BRUSH
ESCOBILLERO SUELO

WJC277A0000065
WHITE / BLANCO

WJC277A0000036
BLACK / NEGRO

WJC277A0000086
SAGE GREEN / VERDE SALVIA

WJC277A0000087
STONE / PIEDRA

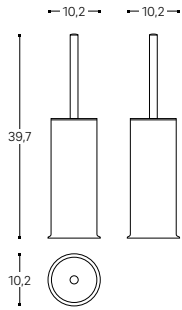

INCH 4x4x15.6



5L WASTE BIN
PAPELERA 5L

WJC277A0002065
WHITE / BLANCO

WJC277A0002036
BLACK / NEGRO

WJC277A0002086
SAGE GREEN / VERDE SALVIA

WJC277A0002087
STONE / PIEDRA

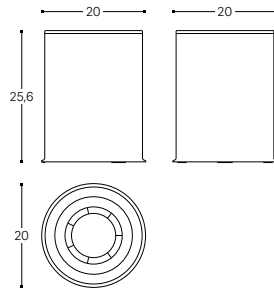

INCH 7.9x7.9x10.1



STOOL
TABURETE

WJC277A0006065
WHITE / BLANCO

WJC277A0006036
BLACK / NEGRO

WJC277A0006086
SAGE GREEN / VERDE SALVIA

WJC277A0006087
STONE / PIEDRA

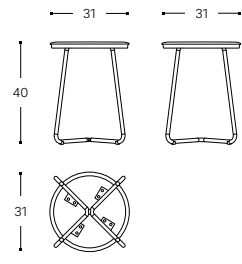

INCH 15.8x15.8x12.2



Inside

Design by Eugeni Quitllet







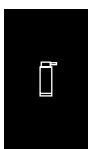

3

YEARS GUARANTEE
AÑOS GARANTÍA

COSMIC

Inside has successfully passed the high demanding tests of long last durability and resistance to extreme uses (static charge or impact testing) to assure long last durability of the product.

Toda la gama Inside ha superado con éxito exigentes tests de durabilidad y resistencia a usos extremos (cargas estáticas o test de impacto), para asegurar una larga vida al producto.



FEATURES / CARACTERÍSTICAS

Accessories manufactured in ABS, a thermoplastic that is known for its great stability and resistance.

Accesorios fabricados en ABS, un termoplástico que destaca por su gran estabilidad y resistencia.

AA

FINISHES / ACABADOS



05
Glossy white
Blanco brillo



06
Glossy black
Negro brillo



66
Glossy stone
Piedra brillo



18
Glossy gray mink
Gris visión brillo



14
Glossy ruby
Rubí brillo

Free standing accessories | Complementos



FREE STANDING BRUSH-HOLDER
PORTACEPILLOS ENCIMERA

- WJC291A0052005**
GLOSSY WHITE / BLANCO BRILLO
- WJC291A0052006**
GLOSSY BLACK / NEGRO BRILLO
- WJC291A0052066**
GLOSSY STONE / PIEDRA BRILLO
- WJC291A0052018**
GLOSSY GRAY MINK / GRIS VISÓN BRILLO
- WJC291A0052014**
GLOSSY RUBY / RUBÍ BRILLO

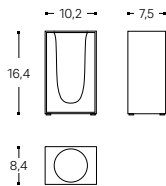

INCH 4x3x6.5



FREE STANDING SOAP DISPENSER
DOSIFICADOR ENCIMERA

- WJC291A0004005**
GLOSSY WHITE / BLANCO BRILLO
- WJC291A0004006**
GLOSSY BLACK / NEGRO BRILLO
- WJC291A0004066**
GLOSSY STONE / PIEDRA BRILLO
- WJC291A0004018**
GLOSSY GRAY MINK / GRIS VISÓN BRILLO
- WJC291A0004014**
GLOSSY RUBY / RUBÍ BRILLO

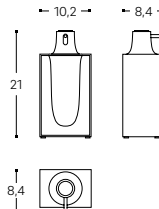

INCH 4x3.3x8.3



FLOOR TOILET BRUSH
ESCOBILLERO SUELO

- WJC291A0000005**
GLOSSY WHITE / BLANCO BRILLO
- WJC291A0000006**
GLOSSY BLACK / NEGRO BRILLO
- WJC291A0000066**
GLOSSY STONE / PIEDRA BRILLO
- WJC291A0000018**
GLOSSY GRAY MINK / GRIS VISÓN BRILLO
- WJC291A0000014**
GLOSSY RUBY / RUBÍ BRILLO

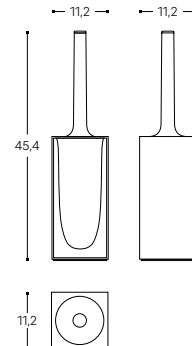

INCH 4.4x4.4x17.9



Saku

Design by **Ricard Ferrer**









Saku has successfully passed the high demanding tests of long last durability and resistance to extreme uses (static charge or impact testing) to assure long last durability of the product.

Toda la gama **Saku** ha superado con éxito exigentes tests de durabilidad y resistencia a usos extremos (cargas estáticas o test de impacto), para asegurar una larga vida al producto.



FEATURES / CARACTERÍSTICAS

Complements in PMMA (Polymethyl methacrylate), coated in transparent paint with a gummy finish.

Complementos realizados en PMMA (poli metil metacrilato) recubiertos con pintura transparente en acabado gomoso.

FINISHES / ACABADOS



025
Soft white
Blanco soft



026
Soft black
Negro soft



028
Soft gray
Gris soft



027
Soft stone
Piedra soft

005
Glossy white
Blanco brillo

006
Glossy black
Negro brillo





SOAP DISH
JABONERA

- ■ ■ ■ **WJC252A0003**___
SOFT / SOFT
- ■ **WJC252A0003**___
GLOSSY / BRILLO

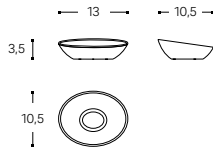

INCH 5.1x4.1x1.4



BRUSH-HOLDER
PORTACEPILLOS

- ■ ■ ■ **WJC252A0052**___
SOFT / SOFT
- ■ **WJC252A0052**___
GLOSSY / BRILLO

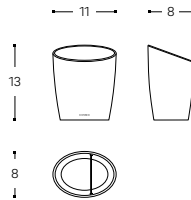

INCH 4.3x3.1x5.1



SOAP DISPENSER
DOSIFICADOR

- ■ ■ ■ **WJC252A0004**___
300 ML SOFT / SOFT
- ■ **WJC252A0004**___
300 ML GLOSSY / BRILLO

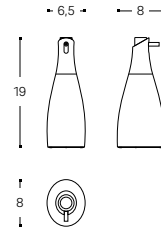

INCH 2.5x3.1x7.5



TOILET BRUSH
ESCOBILLERO

- ■ ■ ■ **WJC252A0000**___
SOFT / SOFT
- ■ **WJC252A0000**___
GLOSSY / BRILLO

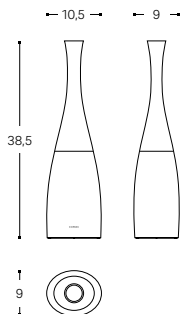

INCH 4.1x3.5x15.1



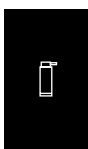





Essentials

- 332 **Shower soap dishes**
Jaboneras de ducha
 - 338 **Waste bin**
Papeleras
 - 342 **Magnifying mirror**
Espejos aumento
 - 348 **Stools**
Taburetes
-



Shower soap dishes



SHOWER SOAP DISH
JABONERA DE DUCHA

WJB006A0030001
CHROME / CROMO

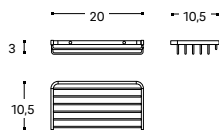

INCH 7.9x4.1x1.2



SHOWER SOAP DISH
JABONERA DE DUCHA

WJB006A0033001
CHROME / CROMO

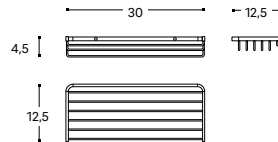

INCH 11.8x4.9x1.8



SHOWER SOAP DISH
JABONERA DE DUCHA

WJB006A0048001
CHROME / CROMO

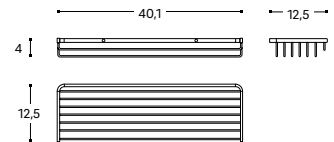

INCH 15.7x4.9x1.6



LEFT TWO-LEVEL SHOWER SOAP DISH
JABONERA DE DUCHA ESCALÓN IZQUIERDO

WJB006A0088001
CHROME / CROMO

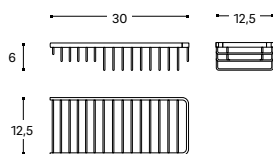

INCH 11.8x4.9x2.4



RIGHT TWO-LEVEL SHOWER SOAP DISH
JABONERA DE DUCHA ESCALÓN DERECHO

WJB006A0087001
CHROME / CROMO

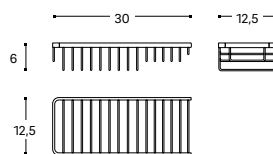

INCH 11.8x4.9x2.4



SHOWER SOAP DISH
JABONERA DE DUCHA

WJB006A0049001
CHROME / CROMO

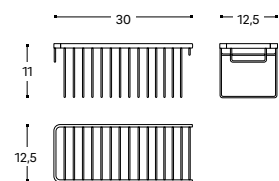

INCH 11.8x4.9x4.3



Jaboneras de ducha



○●
CORNER SHOWER SOAP DISH
JABONERA DE DUCHA RINCÓN

WJB006A0050001
CHROME / CROMO

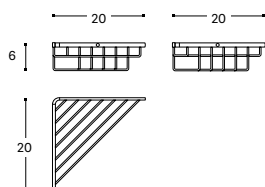

INCH 7.9x7.9x2.4



○●
CORNER SHOWER SOAP DISH
JABONERA DE DUCHA RINCÓN

WJB006A0089001
CHROME / CROMO

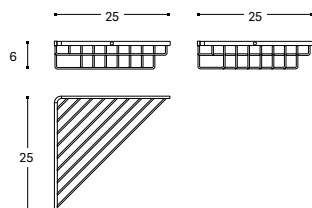

INCH 9.8x9.8x2.4



○●
CORNER SHOWER SOAP DISH
JABONERA DE DUCHA RINCÓN

WJB006A0032001
CHROME / CROMO

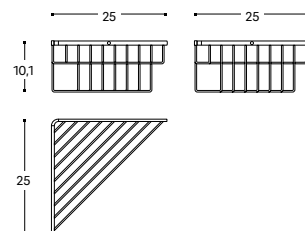

INCH 9.8x9.8x4.3



●
SOAP WIRE BASKET
JABONERA DE DUCHA

WJP014A6023001
CHROME / CROMO

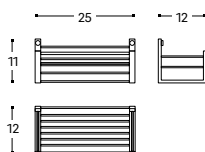

INCH 9.8x4.7x4.3



●
SOAP WIRE BASKET
JABONERA DE DUCHA

WJP014A6024001
CHROME / CROMO

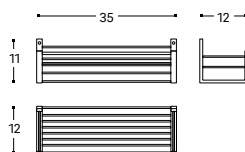

INCH 13.8x4.7x4.3



●
SOAP WIRE BASKET
JABONERA DE DUCHA

WJP014A6025001
CHROME / CROMO

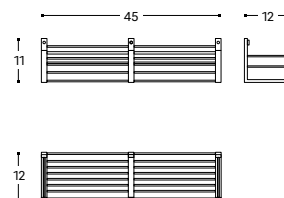

INCH 17.7x4.7x4.3

Shower soap dishes



RACK SOAP DISH REMOVABLE
JABONERA DE DUCHA EXTRAÍBLE

WJP014A6023004
 GOLD / ORO

WJP014A6123001
 CHROME / CROMO

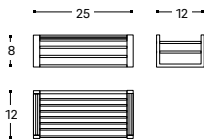

INCH 9.8x4.7x3.2



RACK SOAP DISH REMOVABLE
JABONERA DE DUCHA EXTRAÍBLE

WJP014A6024004
 GOLD / ORO

WJP014A6124001
 CHROME / CROMO

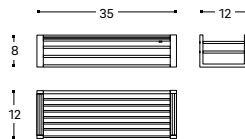

INCH 13.8x4.7x3.2



RACK SOAP DISH REMOVABLE
JABONERA DE DUCHA EXTRAÍBLE

WJP014A6025004
 GOLD / ORO

WJP014A6125001
 CHROME / CROMO

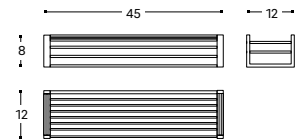

INCH 17.7x4.7x3.2



RACK SOAP DISH REMOVABLE
JABONERA DE DUCHA EXTRAÍBLE

WJP014A6032004
 GOLD / ORO

WJP014A6132001
 CHROME / CROMO

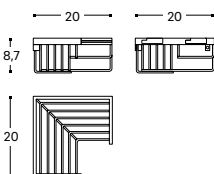

INCH 7.9x7.9x3.4



RACK SOAP DISH REMOVABLE
JABONERA DE DUCHA EXTRAÍBLE

WJP014A6033004
 GOLD / ORO

WJP014A6133001
 CHROME / CROMO

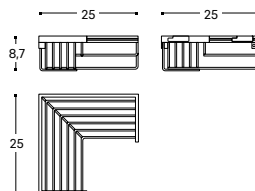

INCH 9.8x9.8x3.4



SHOWER SOAP DISH SET
SET JABONERA DUCHA

WJP014A6001001
 CHROME / CROMO

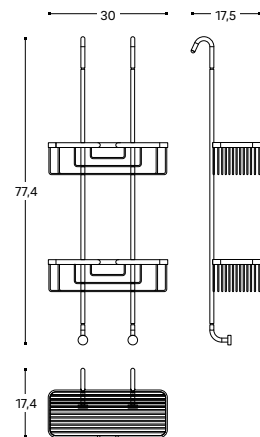

INCH 11.8x4.7x30.7



Jaboneras de ducha

S ALTA DISPONIBILIDAD.
HIGH AVAILABILITY.



⊙
SHOWER SOAP DISH SET
SET JABONERA DUCHA

WJP014A6002001
CHROME / CROMO

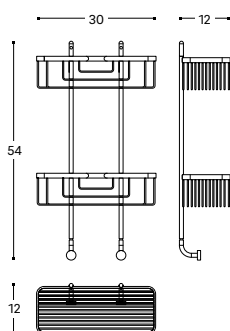

INCH 19.7x3.5x2



⊙
RACK SOAP DISH
JABONERA REJILLA

WJP014A6021001
CHROME / CROMO

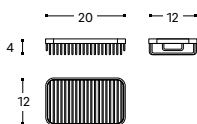

INCH 7.9x4.7x1.6

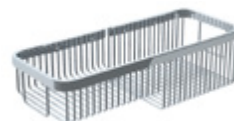

⊙
RACK SOAP DISH
JABONERA REJILLA

WJP014A6022001
CHROME / CROMO

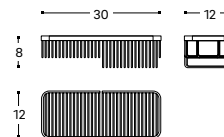

INCH 11.8x3.5x2



⊙
CORNER RACK SOAP DISH
JABONERA REJILLA RINCÓN

WJP014A6031001
CHROME / CROMO

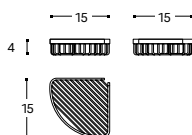

INCH 5.9x5.9x1.6



⊙
CORNER RACK SOAP DISH
JABONERA REJILLA RINCÓN

S **WJP014A6032001**
CHROME / CROMO

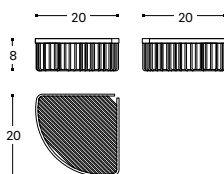

INCH 7.9x7.9x3.2



⊙
CORNER RACK SOAP DISH
JABONERA REJILLA RINCÓN

WJP014A6033001
CHROME / CROMO

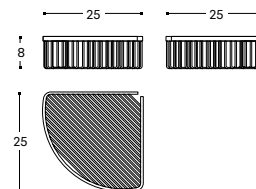

INCH 9.8x9.8x3.2

Shower soap dishes

ALTA DISPONIBILIDAD.
HIGH AVAILABILITY.



◎
CORNER RACK SOAP DISH
JABONERA REJILLA RINCÓN

WJP014A6034001
CHROME / CROMO

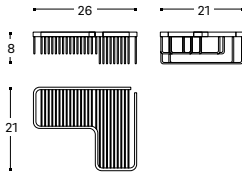

INCH 10.2x8.3x3.2



◎
SOAP WIRE BASKET
JABONERA DE DUCHA

WJP014A6020001
CHROME / CROMO

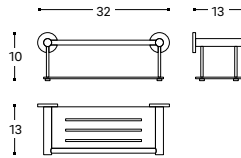

INCH 12.6x3.9x5.1



◎
SOAP WIRE BASKET
JABONERA DE DUCHA

WJP075A6020001
CHROME / CROMO

38x15x11 CM · INCH 15x4.5x5.9









Waste bin

Papeleras



Waste bin



WASTE BIN
PAPELERA

- WJC292A0002003**
3L BRUSHED STAINLESS STEEL / INOX CEPILLADO
- WJC292A0002036**
3L MATTE BLACK / NEGRO MATE
- WJC292A0003003**
5L BRUSHED STAINLESS STEEL / INOX CEPILLADO
- WJC292A0003036**
5L MATTE BLACK / NEGRO MATE

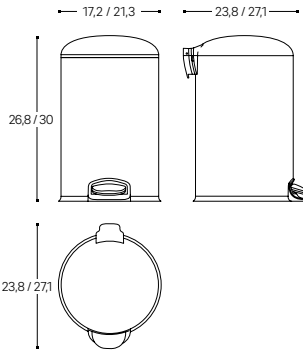

INCH 10.3x12.6x16.5



WASTE BIN
PAPELERA

- WJC292A0004003**
5L BRUSHED STAINLESS STEEL / INOX CEPILLADO
- WJC292A0004036**
5L MATTE BLACK / NEGRO MATE

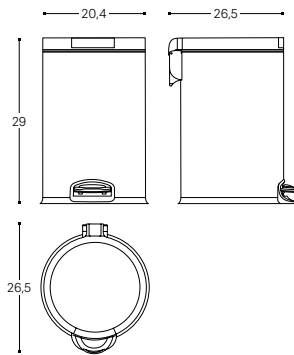

INCH 9.8x12.4x15.6



AUTOMATIC BIN
PAPELERA AUTOMÁTICA

- WJC290A6521000**
28L BRUSHED STAINLESS STEEL / INOX CEPILLADO
- WJC290A6520000**
28L MATTE BLACK / NEGRO MATE

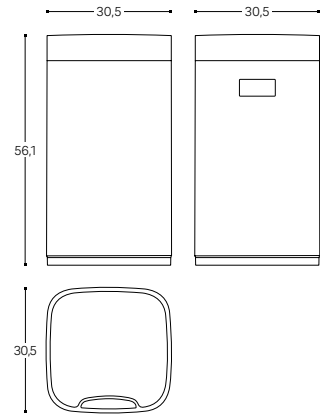

INCH 12x12x22.1



STEP BIN
PAPELERA DE PEDAL

- WJC290A6523000**
28L BRUSHED STAINLESS STEEL / INOX CEPILLADO
- WJC290A6522000**
28L MATTE BLACK / NEGRO MATE

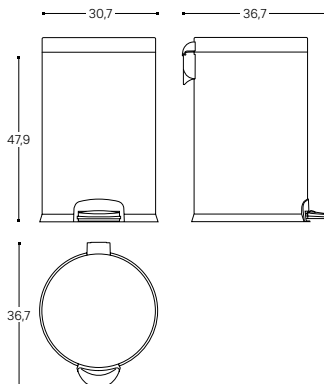

INCH 12.1x14.5x15.6



WASTE BIN
PAPELERA

- WJC235A0002001**
5L CHROME / CROMO
- WJC235A0002003**
5L BRUSHED STEEL / INOX CEPILLADO
- WJC277A0002036**
5L SOFT BLACK
- WJC277A0002065**
5L WHITE / BLANCO
- WJC277A0002086**
5L SAGE GREEN / VERDE SALVIA
- WJC277A0002087**
5L STONE / PIEDRA

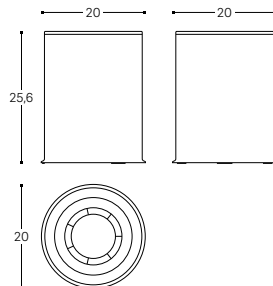

INCH 7.9x7.9x10.1



WASTE BIN
PAPELERA

- WJC205A0702002**
3L GLOSSY STAINLESS STEEL / INOX BRILLO
- WJC205A0703002**
5L GLOSSY STAINLESS STEEL / INOX BRILLO
- WJC205A0704002**
12L GLOSSY STAINLESS STEEL / INOX BRILLO

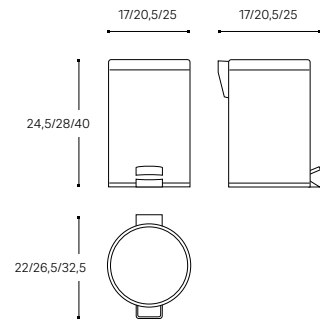

INCH 6.7/8.1/9.8x6.7/8.1/9.8x9.6/11/15.7









Magnifying mirror

Espejos
aumento



Magnifying mirror

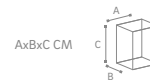

WALL MAGNIFYING MIRROR WITH ADJUSTABLE LED LIGHT
ESPEJO AUMENTO DE PARED CON LUZ LED REGULABLE

3W 100-250V

WJC292A0084001
X5 CHROME / CROMO

WJC292A0084036
X5 BLACK MATE / NEGRO MATE

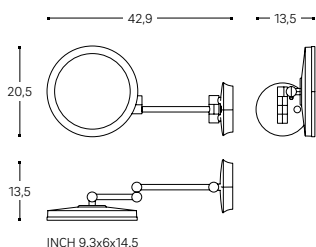

WALL MAGNIFYING MIRROR
ESPEJO DE AUMENTO PARED

WJC292A0083001
X5 CHROME / CROMO

WJC292A0083036
X5 BLACK MATE / NEGRO MATE

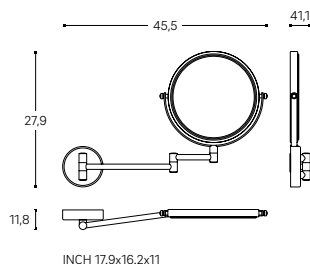

WALL MAGNIFYING MIRROR
ESPEJO DE AUMENTO PARED

WJC235A0085001
X5 CHROME / CROMO

WJC235A0085003
X5 CHROME / CROMO

WJC235A0085036
X5 BLACK MATE / NEGRO MATE

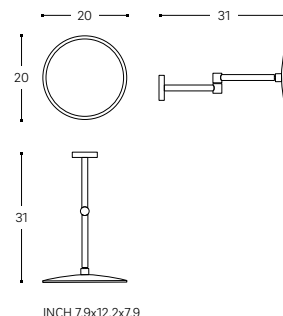

WALL MAGNIFYING MIRROR
ESPEJO DE AUMENTO PARED

WJC251A0085061
X3 CHROME-BLACK / CROMO-NEGRO

WJC251A0085051
X3 CHROME-WHITE / CROMO-BLANCO

WJC238A0085005
X3 GLOSSY WHITE / BLANCO BRILLO

WJC238A0085065
X3 MATTE WHITE / BLANCO MATE

WJC238A0085006
X3 GLOSSY BLACK / NEGRO BRILLO

WJC238A0085036
X3 MATTE BLACK / NEGRO MATE

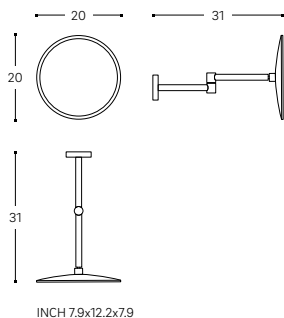

WALL MAGNIFYING MIRROR
ESPEJO DE AUMENTO PARED

WJC240A0086001
X3 CHROME / CROMO

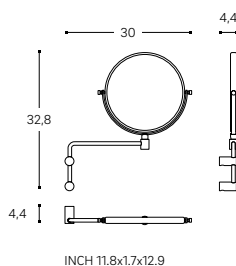

WALL MAGNIFYING MIRROR
ESPEJO DE AUMENTO PARED

WJP090A8150001
X3 CHROME / CROMO

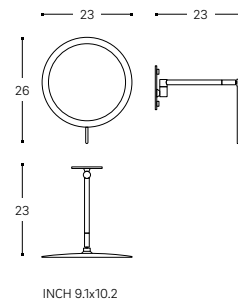

Espejos aumento



WALL MAGNIFYING MIRROR
ESPEJO DE AUMENTO PARED

WJP090A8151001
X3 CHROME / CROMO

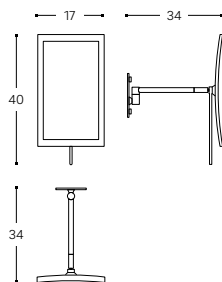

INCH 9.4x6.7x11



WALL MAGNIFYING MIRROR
ESPEJO DE AUMENTO PARED

WJP090A8152001
X3 CHROME / CROMO

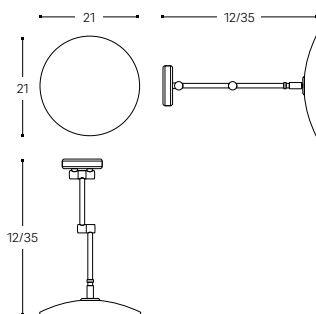

INCH 8.3x4.7x13.8x8.3



WALL MAGNIFYING MIRROR
ESPEJO DE AUMENTO PARED

WJP090A8153001
X3 CHROME / CROMO

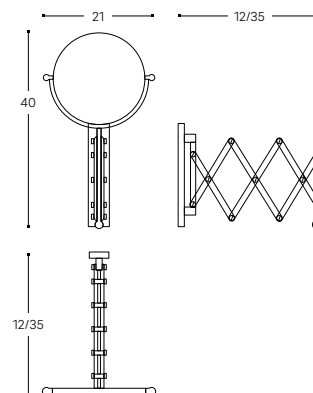

INCH 8.3x4.7x13.8x15.7



WALL MAGNIFYING MIRROR LED
ESPEJO DE AUMENTO PARED LED
LED 3X1 - 2W CLAS. IP-30

WJP090A8251001
X3 CHROME / CROMO

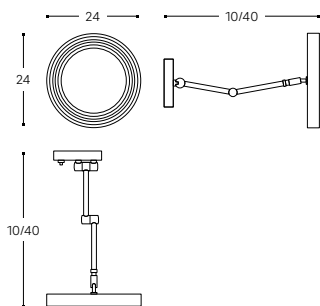

INCH 9.4x3.9x15.7x9.4



Magnifying mirror

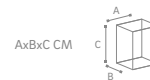

○△◇
 FREE-STANDING MAGNIFYING MIRROR
 WITH ADJUSTABLE LED LIGHT
 ESPEJO AUMENTO DE ENCIMERA CON LUZ LED REGULABLE
 3W

WJC292A0088001
 X5 CHROME / CROMO
WJC292A0088036
 X5 BLACK MATE / NEGRO MATE

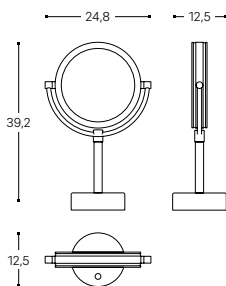

INCH 9.3x6x14.5



○△◇
 FREE-STANDING MAGNIFYING MIRROR
 WITH ADJUSTABLE LED LIGHT
 ESPEJO AUMENTO DE ENCIMERA CON LUZ LED REGULABLE
 3W

WJC292A0087001
 X5 CHROME / CROMO
WJC292A0087036
 X5 BLACK MATE / NEGRO MATE

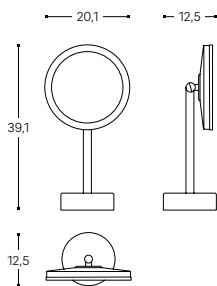

INCH 7.9x4.9x15.4



○△◇
 FREE STANDING MAGNIFYING MIRROR
 ESPEJO AUMENTO ENCIMERA

WJC292A0086001
 X5 CHROME / CROMO
WJC292A0086036
 X5 BLACK MATE / NEGRO MATE

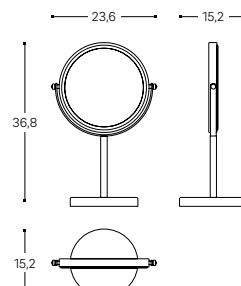

INCH 9.3x6x14.5



○△◇
 FREE STANDING MAGNIFYING MIRROR
 ESPEJO AUMENTO ENCIMERA

WJC292A0085001
 X5 CHROME / CROMO
WJC292A0085036
 X5 BLACK MATE / NEGRO MATE

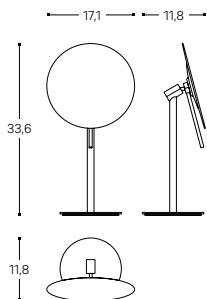

INCH 6.7x4.7x13.2



◎△◇
 WALL MAGNIFYING MIRROR
 ESPEJO DE AUMENTO PARED

WJC251A0083061
 X3 CHROME-BLACK / CROMO-NEGRO
WJC251A0083051
 X3 CHROME-WHITE / CROMO-BLANCO
WJC238A0083005
 X3 GLOSSY WHITE / BLANCO BRILLO
WJC238A0083065
 X3 MATTE WHITE / BLANCO MATE
WJC238A0083006
 X3 GLOSSY BLACK / NEGRO BRILLO
WJC238A0083036
 X3 MATTE BLACK / NEGRO MATE

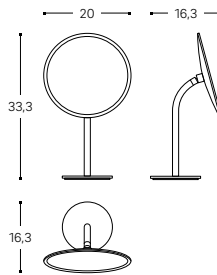

INCH 7.9x6.4x13.1



○◇
 WALL MAGNIFYING MIRROR
 ESPEJO DE AUMENTO PARED

WJC277A0084065
 X5 WHITE / BLANCO
WJC277A0084036
 X5 BLACK / NEGRO
WJC277A0084086
 X5 SAGE GREEN / VERDE SALVIA
WJC277A0084087
 X5 STONE / PIEDRA

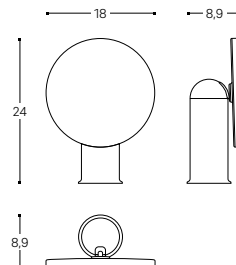

INCH 7.1x3.5x9.5



Espejos aumento



FREE STANDING MAGNIFYING MIRROR
ESPEJO AUMENTO ENCIMERA

WJP090A8108001
X3 CHROME / CROMO

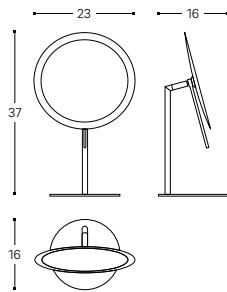

INCH 9.1x6.3x14.6



FREE STANDING MAGNIFYING MIRROR
ESPEJO AUMENTO ENCIMERA

WJP090A8109001
X3 CHROME / CROMO

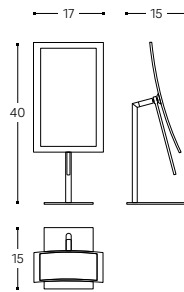

INCH 6.7x5.9x15.7



FREE STANDING MAGNIFYING MIRROR
ESPEJO AUMENTO ENCIMERA

WJP026A8104004
GOLD / ORO

WJP026A8104001
CHROME / CROMO

WJP026A8104014
CHROME-GOLD / CROMO-ORO

WJP026A8104011
OLD BRASS / LATÓN VIEJO

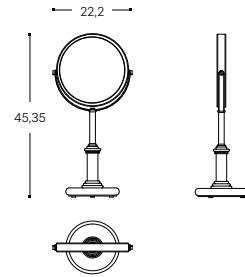

INCH 9.1x9.1x18.1





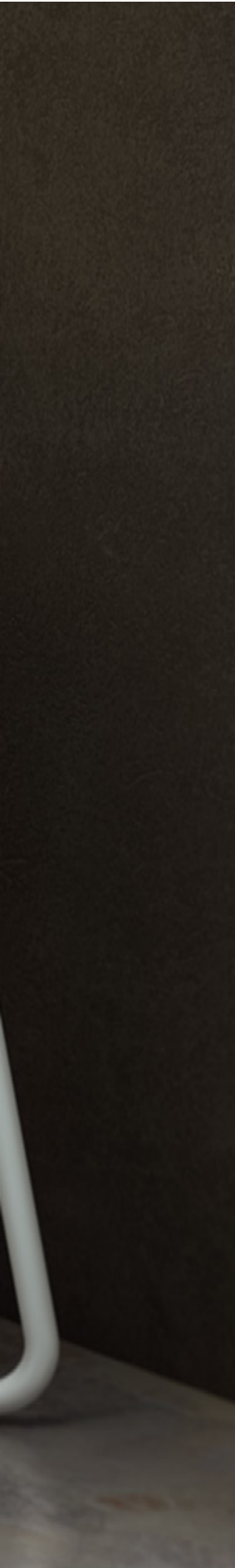

Stools

Taburetes



Stools



○△
STOOL
TABURETE

WJC205A0006065
CHROME-MATTE WHITE / CROMO-BLANCO MATE

WJC205A0006036
CHROME-MATTE BLACK / CROMO-NEGRO MATE

WJC277A0006065
WHITE / BLANCO

WJC277A0006036
BLACK / NEGRO

WJC277A0006086
SAGE GREEN / VERDE SALVIA

WJC277A0006087
STONE / PIEDRA

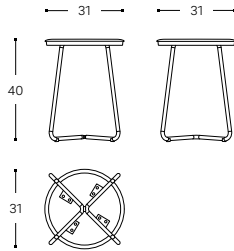

INCH 15.8x15.8x12.2



○□△
STOOL
TABURETE

WJC268A0616642
CHROME-CLEAR OAK / CROMO-ROBLE CLARO

WJC268A0616641
MATTE BLACK-CLEAR OAK / NEGRO MATE-ROBLE CLARO

WJC268A0616639
MATTE WHITE-CLEAR OAK / BLANCO MATE-ROBLE CLARO

WJC268A0616634
CHROME-DARK OAK / CROMO-ROBLE OSCURO

WJC268A0616632
MATTE BLACK-DARK OAK / NEGRO MATE-ROBLE OSCURO

WJC268A0616633
MATTE WHITE-DARK OAK / BLANCO MATE-ROBLE OSCURO

WJC268A0616653
CHROME-MATTE WHITE / CROMO-BLANCO MATE

WJC268A0616654
MATTE BLACK-MATTE WHITE / NEGRO MATE-BLANCO MATE

WJC268A0616655
MATTE WHITE-MATTE WHITE / BLANCO MATE-BLANCO MATE

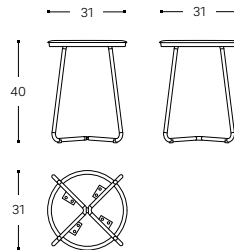

INCH 15.8x15.8x12.2





Spare parts

Recambios



[https://www.icosmic.com/tarifas/recambios/
BR_RECANVIS_EXP%20EN-ES%20SP%2023.pdf](https://www.icosmic.com/tarifas/recambios/BR_RECANVIS_EXP%20EN-ES%20SP%2023.pdf)



Materials



FLOAT GLASS (Flat shelves and washbasin tops)

Made using standard FLOAT type glass that has undergone no subsequent treatment other than the necessary machining, cutting and polishing. Therefore, it is a naturally fragile material and despite the fact that the most appropriate density has been used in every case, special care should be taken when using it. 100% recyclable.



PRESSED GLASS

(Most of the glasses and soap dishes in our collection)

A very similar material to the FLOAT glass used for the shelves, glasses, and soap dishes, etc. This molten glass is shaped in a mould. These products should be used and cared for in the same way as the shelves and washbasin tops. 100% recyclable.



TEMPERED GLASS

This material is manufactured similarly to FLOAT glass, but also undergoes a thermal processing to increase its resistance. 100% recyclable.



MIRRORS

Sheet of glass covered by layers of silver, copper and, finally, paint. The use of topquality raw materials in conjunction with the correct mirror manufacturing process guarantee maximum protection against stains caused by corrosion.



SYNTHETIC RESIN

Is a technologically advanced and unique compound, made up of high percentage of mineral extenders from nature (ATH derived from bauxite) as well as a small one of high-pureness polyester and acrylic polymers; therefore, it is an inert, hypoallergenic and non-toxic material. 100% recyclable, practically fireproof (class 1), strongly UV-resistant, solid and nonporous, hygienic and healthy, resistant and agreeable to the touch for its velvety and natural.



CRISTALPLANT BIOBASED®

Material made up of 50% natural minerals (aluminium trihydrate -ATH- derived from bauxite) and 50% high-purity polyester bioresins. Plant resins; this is the first ecologically sustainable solid surface, consisting of resins of plant origin and extremely pure natural minerals. It is an inert, hypoallergenic, non-toxic material. It is practically inflammable, certified Class 1 fire resistance. It is highly resistant to ultraviolet rays. It regains its original appearance with just soapy water and a scrubber.



PHENOLIC RESIN

This material is a high pressure laminate (HPL) with a decorative surface. Typically the superficial layer consists of thermo-hardened resin-treated plywood. The special texture and durability of this material makes it very resistant to impact and scratching, and it is completely waterproof. Specially designed for use in places where hygiene is of the utmost importance, this material can be cleaned frequently with active detergents, chemical agents, or organic solvents.



VENEERED WOOD

MDF boards + oak veneer varnished with fine quality materials to prevent yellowing. Oak wood is a material that is very resistant to biological agents (fungus and insects). As this kind of material is natural wood, it may present knots and color variation.



LACQUERED WOOD

This material is made from double-faced MDF plywood. Its high quality varnish provides a bright or matte finish and prevents yellowing. Due to its delicate lacquered surface, we recommend the use of mild cleaning products, avoiding solvents or any abrasive substances.



PVC

Polyvinyl chloride (PVC) is a polyvinyl chloride polymer used to manufacture numerous products and is also applied in making boards, panels, windows, shutters, etc. Its durability, colour stability, watertightness and moisture proof properties make PVC an ideal material for bathroom and kitchen furniture. The material can be cleaned quickly and easily with just soap and water, although its resilience means most cleaning products can also be used.



PLASTIC

We use various technical plastics with different features to meet the manufacturing and aesthetic needs of each product. These include ABS (with or without chrome), PP, PA, PE, PC, PS, etc.



ACRYLIC GLASS

The polymethylmetacrylate (PMMA) is known as one of the "engineering plastics", and is obtained through the polymerisation of methyl methacrylate. It stands out from other plastics due to the fact that it is impact resistant, weather resistant—as it does not undergo any significant ageing in ten years of outdoor exposure—resistant to UVA rays and scratch resistant. Due to its absolute transparency (it is the most transparent plastic), it is most commonly used in vehicle headlights, optics, medicine or partition panels. For use in architecture and decoration, it is lighter than glass and provides greater resistance to impact, meaning it can be a good substitute in many situations.



STAINLESS STEEL

It is an alloy of iron and carbon. Steel maintains the iron hardness characteristics. This steel has a special chrome treatment against the rust and oxidation. The used alloys are SS201 & SS304.



BRASS OR SIMILAR ALLOYS (glossy chrome and matt chrome)

A copper and zinc alloy—this is one of the non-ferrous metals, the proportion of which varies according to its use. It offers greater malleability than both copper and zinc separately, and it is easily refined which allows for a high level of design customization.



ALUMINUM

Aluminium alloy. May be presented as solid, extruded and calibrated. Aluminium is an important metal for numerous industries, such as the automotive industry where it is most common. It is generally a soft metal with low melting points.



GLASS-LINED STEEL (VIT-TECH)

Cutting-edge, 100% recyclable, non-porous and hygienic material made of fired pre-enamelled sheet steel. The vitreous enamel withstands corrosion, high temperatures and chemical agents. This durability means it can be used for a wide range of functional applications in bathtubs, shower trays and washbasins, as well as for ovens and coatings. It is an easy to clean material that does not require special cleaning products.





TECKSTONE

Advanced formula composed by natural minerals (calcium carbonate and quartz) mixed with resin. The surface is covered by Gelcoat Premium Maxguard™ film, with plastic fibre and polymer, which provides the needed durability and resistance for an intensive daily use. It is a solid surface with excellent physic-mechanical properties that supplies important design possibilities. Its capacity of moulding allows reproducing forms with a great precision and with less curvature radius. Teckstone is very hard, resistant and compact; being a non porous material and without angles, it is very easy to maintain, the stains can be eliminated without effort and it is easy to clean.



MARBLE

Carrara Marble. Extracted from Italy's Tuscan quarries, each piece of marble is different and each stone has its own unique characteristics. Its white background has distinctive light blue-grey veins running through its surface.

Marquina Marble. Elegant and classic, each piece of marble is different and every stone has its own characteristics. Extracted from the quarries sited in Marquina (Vizcaya), it is characterized by its white veins on the black stone. The less veins it has, more appreciated is.

Brescia Marble. (Brown matt and glossy) from the region of Lombardy (Italy). It is considered as one of the most sumptuous Italian marble.



PORCELAIN

Ceramic product obtained from a sophisticated paste made up of kaolin, feldspar and quartz. Porcelain is treated with a vitrified top finish for surface hardness, colour and sheen. It is non-porous and hygienic, which makes it suitable for use in the bathroom. The vitrified finish means that it can be cleaned with any bathroom-specific product.



FÉNIX®

Soft touch material and high performance: micro-scratch thermal reparability, anti-fingerprint, scratch resistance, high resistance to solvents and low light reflectivity. FÉNIX® products are made of paper (more than 60%) and thermosetting resins (30-40%). They are created through a pressure process in which heat and pressure are applied simultaneously to obtain a homogeneous non-porous product. The core structure is made of paper, impregnated with thermosetting resins. The outer surface is treated with the latest generation acrylic resins, hardened and set using the Electron Beam Curing process. It does not require any special maintenance, just a damp cloth with warm water or mild detergents. To remove the most common stains the surface can be cleaned with just warm water and a non-abrasive cloth. If the residue is old or has hardened, use a magic eraser sponge or a soft cloth to remove it. Always rinse thoroughly to remove detergent with clean, preferably warm water. Tests have shown that the removal of superficial micro-scratches using a "magic sponge" takes place both immediately and after 24 hours.



SOLIDMAT

A solid surface with a high percentage of natural mineral deposits. It stands out for its glossy feel and its durability. It is a fireproof material, compact and non-porous and both hygienic and resistant. Available in solid matt white.

CLEANING INSTRUCTIONS

Clean with a liquid domestic cleaner or with soap suds. Afterwards rinse with clear water and polish with a cloth. Do not use any cleaning agents containing acid or scouring agents. Damage caused by improper treatment is not subject to our guarantee.



Materiales



VIDRIO FLOAT (Estantes y encimeras)

Realizado con vidrio tipo FLOAT estándar sin ningún otro tratamiento posterior más que la mecanización, corte y pulido necesarios. Se trata, pues, de un material que por su propia naturaleza es frágil y a pesar de que en cada caso se ha utilizado el espesor más adecuado, debe tenerse un especial cuidado en su uso. 100% reciclable.



VIDRIO PRENSADO (Vasos y jaboneras de la mayoría de nuestras series)

Material muy similar al vidrio FLOAT utilizado en estantes, vasos, jaboneras... Este vidrio fundido es conformado en un molde. El uso y cuidados deben ser los mismos que para estantes y encimeras. 100% reciclable.



VIDRIO TEMPLADO

Vidrio FLOAT sometido a tratamiento térmico para aumentar su resistencia. 100% reciclable.



ESPEJOS

Plancha de vidrio sobre la que se aplica una capa de plata, cobre y finalmente pintura. El uso de materia prima de primera calidad, unido a un correcto proceso de fabricación de los espejos, aseguran la mayor protección contra las manchas por corrosión.



RESINA SINTÉTICA

Es un material compuesto tecnológicamente avanzado y único, formado por un porcentaje elevado de minerales naturales (trihidrato de aluminio -ATH- derivado de la bauxita) y un bajo porcentaje de polímeros poliésteres y acrílicos de gran pureza; se trata, por lo tanto, de un material inerte, hipoalérgico y no tóxico. Es un material que puede reciclarse al 100%, prácticamente ignífugo (clase 1), con una óptima resistencia a los rayos ultravioletas; es compacto, no poroso, higiénico, resistente y agradable al tacto gracias a su acabado aterciopelado, similar al de la piedra natural.



CRISTALPLANT BIOBASED®

Material compuesto formado por un 50% de minerales naturales (trihidrato de aluminio -ATH- derivado de la bauxita) y un 50% de biorresinas de poliéster de gran pureza. Es el primer solid surface eco sostenible que deriva de materias primas resinosas de origen vegetal, procedentes de cultivos certificados, mezcladas con minerales naturales de extrema pureza. Es un material inerte, hipoalérgico y no tóxico. Es prácticamente ignífugo, con certificado de resistencia al fuego Clase 1. Presenta una óptima resistencia a los rayos ultravioletas. Puede recuperar completamente su aspecto original utilizando simplemente agua jabonosa y estropajos abrasivos.



RESINA FENÓLICA

La Resina Fenólica o Stratificato es un laminado de alta presión (HPL) con superficie decorativa. En general, la capa superficial está constituida por una superficie dura, basada en resinas de melamina, mientras que el grueso está constituido por un contrachapado impregnado de resina termo endurecida que le confiere al material una excepcional resistencia al impacto. Su especial textura y su durabilidad proporcionan una excelente resistencia al rayado. Gracias a su superficie perfectamente impermeable es un material resistente al desgaste, al agua y al vapor.



MADERA CHAPADA

Tableros de DM + chapa de roble barnizado con materiales de primera calidad que evitan el amarillamiento. La madera de roble es un material muy resistente a los agentes biológicos (hongos e insectos), al ser una madera natural puede mostrar nudos y presentar variaciones de color entre piezas.



MADERA LACADA

Tablero DM melaminado dos caras y lacado en acabados brillo y mate con barnices de primera calidad resistentes y que evitan el amarillamiento. Las superficies lacadas son delicadas y deben ser tratadas y limpiadas cuidadosamente, utilizando productos específicos para estas superficies. No usar nunca disolventes o productos abrasivos.



PVC

El cloruro de polivinilo (PVC) es un polímero de cloruro de vinilo que se emplea para la fabricación de multitud de productos, encontrando aplicación en la realización de tableros, paneles, ventanas, persianas, etc. La larga durabilidad, estabilidad del color, estanqueidad al agua y resistencia a la humedad, son las características que hacen del PVC un material idóneo para muebles de baño y de cocina. La limpieza de este material es fácil y rápida y se realiza con agua y jabón, aunque por su resistencia permite el empleo la mayoría de productos de limpieza.



PLÁSTICO

Cosmic utiliza plásticos técnicos de distintas características en función de las necesidades de fabricación y estéticas de cada producto o pieza. Entre los plásticos utilizados están: ABS (cromado o no), PP, PA, PE, PC, PS, etc.



CRISTAL ACRÍLICO

El Polimetilmetacrilato (PMMA) es conocido como uno de los "plásticos de la ingeniería", se obtiene de la polimerización del metacrilato de metilo. Destaca frente a otros plásticos por la resistencia a los impactos, a la intemperie, ya que no sufre un envejecimiento apreciable en diez años de exposición exterior y a los rayos UVA, y por la resistencia al rayado. Por su transparencia máxima (es el plástico más transparente), las funciones más habituales van desde los faros de los vehículos, la óptica, la medicina o mamparas separadoras. Para su uso en la arquitectura y decoración se beneficia de un peso menor al del vidrio y mayor resistencia a impactos por lo cual puede ser un buen sustituto en muchas ocasiones.



ACERO INOXIDABLE

Aleación de hierro con carbono que conserva las propiedades de dureza del hierro. Se trata de un acero con un tratamiento especial de cromo, contra la corrosión y oxidación. Las aleaciones utilizadas son la SS303 y SS304.



LATÓN O ALEACIONES ANÁLOGAS (cromo brillante y cromo mate)

Aleación de cobre y zinc, es uno de los metales no férricos, cuya proporción varía en función de su aplicación. Destaca su maleabilidad, más alta que la del cobre y zinc por separado, y fácil pulido lo cual permite un alto grado de adaptación en el diseño de las piezas.





ALUMINIO

Aleación de aluminio. Se puede presentar como macizo extrusionado, estirado y calibrado. El aluminio es un metal importante para una gran cantidad de industrias, como la del automóvil, donde se utiliza habitualmente. Tiende a ser blando y presenta puntos de fusión bajos.



ACERO VITRIFICADO (VIT-TECH)

Material tecnológicamente avanzado y 100% reciclable que nace de la cocción de una superficie de acero esmaltada previamente. Es un material no poroso, higiénico y resistente a la corrosión, a las altas temperaturas y a agentes químicos debido a la naturaleza vítrea del esmalte. Esta característica le confiere una gran dureza permitiendo una amplia gama de aplicaciones en bañeras, platos de ducha y lavabos así como hornos y revestimientos. Es un material de fácil limpieza que no requiere la utilización de productos de limpieza específicos.



TECKSTONE

Formulación avanzada compuesta de minerales naturales (carbonato de calcio y cuarzo) mezclados con resina. La película Gelcoat Premium Maxguard™, con fibras de plástico y polímeros, recubre la superficie proporcionando la durabilidad y resistencia que necesita el uso diario intensivo. Se trata de una superficie sólida con excelentes propiedades físico-mecánicas que ofrece grandes posibilidades de diseño. Su capacidad de moldeo permite reproducir formas con gran precisión y con menores radios de curvatura. Teckstone es muy resistente, compacto y de gran dureza. Al ser un material no poroso y carente de juntas, su mantenimiento es muy sencillo, las manchas se eliminan sin esfuerzo y es de fácil limpieza.



MÁRMOL

Mármol carrara (Blanco mate y brillo). Extraído de las canteras de la Toscana italiana, cada pieza de mármol es diferente y cada piedra tiene sus propias características. Con fondo blanco tiene distintivas vetas de color azul grisáceo claro repartidas por toda la superficie.

Mármol marquina (negro mate y brillo). Elegante y clásico, cada pieza de mármol es diferente y cada piedra tiene sus propias características. Se extrae de las canteras en Marquina (Vizcaya) y se caracteriza por sus vetas de color blanco sobre la piedra negra. Cuantas menos vetas, más apreciado.

Mármol brescia (marrón mate y brillo). Extraído de las canteras de la región de Lombardía (Italia). Considerado uno de los mármoles italianos más suntuosos.



PORCELANA

Producto cerámico que se obtiene a partir de una pasta muy elaborada compuesta por caolín, feldespato y cuarzo. La porcelana es tratada con un acabado final vitrificado que da a la superficie la dureza superficial, color, brillo, no porosidad e higiene idóneos para su uso en el baño. Este vitrificado permite limpiarla con cualquier producto destinado a la limpieza del baño.



FÉNIX®

Material suave al tacto de elevadas prestaciones: reparabilidad térmica de micro-arañazos, anti-huella digital, resistencia a los arañazos, alta resistencia a los disolventes y reflectancia mínima a la luz. Los productos de FENIX® están realizados de papel (más del 60 %) y de resinas termoendurecedoras (30-40 %). Están creados por un proceso de presión en el que el calor y la presión se aplican de manera simultánea para obtener un producto homogéneo no poroso. La estructura del núcleo está compuesta de papel, impregnado con resinas termoendurecedoras. La superficie exterior está tratada con resinas acrílicas de nueva generación, endurecidas y fijadas con el proceso Electron Beam Curing. No requiere ningún mantenimiento especial, solo un paño húmedo con agua templada o detergentes suaves. Para las manchas más comunes es suficiente con limpiar la superficie con agua templada usando un paño no abrasivo. Si los residuos son antiguos o se han endurecido, usar una esponja mágica o un paño suave para eliminarlos. Siempre enjuagar a fondo para eliminar el detergente con agua limpia, preferiblemente tibia. Las pruebas han demostrado que la eliminación de micro-arañazos superficiales mediante "esponja mágica" tiene lugar tanto inmediatamente como después de 24 horas.



SOLIDMAT

Un solid surface con un alto porcentaje de cargas minerales naturales. Destaca por su tacto satinado y su durabilidad. Es un material ignífugo, compacto y no poroso, higiénico y resistente. Disponible en blanco mate homogéneo.

INSTRUCCIONES DE LIMPIEZA

Las superficies pueden limpiarse con productos de limpieza líquidos o con agua jabonosa. (Tener en cuenta las instrucciones de uso del fabricante de detergentes). A continuación aclarar con abundante agua y pulir con una gamuza. No utilizar productos de limpieza que contengan ácidos, vinagre o que sean abrasivos. No nos responsabilizaremos si los desperfectos se producen a causa de un manejo inadecuado.



Sales conditions

EXPORT GENERAL SALES CONDITIONS

- 1**

The sales of INDUSTRIAS COSMIC S.A.U. are ruled by the herewith detailed general sales condition and the delivery of any order implies the buyer's acceptance of these general conditions.
- 2**

The products can be modified, replaced or cancelled at any time and all information of any kind included in our catalogues, price lists or advertising materials are indicative.
- 3**

Orders received from customers or through our salesmen are always subject to our previous approval and are considered confirmed unless otherwise specified.
- 4**

No order accepted by INDUSTRIAS COSMIC, S.A.U. can be amended or cancelled without our approval. The customer, as far as he is concerned, cannot return any goods to us without our previous acceptance or consent.
- 5**

Goods will be invoiced in accordance with our current price list at the moment of shipment. The prices are F.C.A. Barcelona for orders above € 1,500; for orders below € 1,500 goods will be shipped under Ex-Works conditions.
- 6**

Unless otherwise agreed, the payment terms are:
-Irrevocable Letter of Credit at sight
-Advanced Bank Transfer
-Cash Against Documents
- 7**

INDUSTRIAS COSMIC, S.A.U. offers 3 years guarantee, in exception of the indicated in the price list, against raw material and manufacturing defects. The guarantee is valid from the time of purchase by the final customer. To confirm the date of purchase, the invoice of the consumer should be provided. The guarantee consists of the replacement of the defective piece that impedes the regular use of the item, except in case of improper use, incorrect assembly or installation, natural wear and tear, improper maintenance or, chemical, electrochemical or electrical influences. We are not responsible for all the damage brought about by misuse or bad installation of the products and won't accept any indemnities for the replacement of defective pieces or any demands for damage.
- 8**

INDUSTRIAS COSMIC, S.A.U. always try to minimize the customer service time and to meet the lead time requirements on our customers' orders as much as possible. In case we cannot satisfy them, customers will be duly advised.
- 9**

Ordered COSMIC products will be delivered under reservation of title in favour of INDUSTRIAS COSMIC, S.A.U. until all payment obligations by the purchaser have been met in full.
- 10**

In case of outstanding payments, the return and bank expenses are on the purchaser's. INDUSTRIAS COSMIC S.A.U. has the right to block all orders accepted as long as the outstanding payments are not sorted out.
- 11**

In case of claims regarding the interpretation or execution of the herewith sales conditions, will be competent the courts of our head office's jurisdiction.
- 12**

COSMIC provides information on the certifications with which we comply as a manufacturer. It is the responsibility of the fitter to know the local certifications required in the relevant country.



Condiciones de venta

CONDICIONES GENERALES DE VENTA EXPORTACIÓN

- 1**
Las ventas de INDUSTRIAS COSMIC, S.A.U. se realizan según las condiciones generales aquí expuestas y la entrega de cualquier pedido supone la aceptación, por parte del comprador, de dichas condiciones generales de venta.
- 2**
Los productos se pueden modificar, reemplazar o suprimir en todo momento y la información de cualquier naturaleza contenida en nuestros catálogos, tarifas o material publicitario es indicativa.
- 3**
Los pedidos recibidos directamente de los clientes o realizados por nuestros representantes en nombre de ellos siempre estarán sujetos a nuestra aceptación. INDUSTRIAS COSMIC, S.A.U. da por confirmados todos los pedidos recibidos y, si no hay notificación específica se entenderán como aceptados.
- 4**
Ningún pedido aceptado por nosotros se podrá retractar ni anular sin nuestra aceptación. El cliente, por su parte, no podrá efectuar ninguna devolución de mercancía sin nuestro consentimiento previo.
- 5**
La mercancía será facturada de acuerdo con nuestra tarifa vigente en el momento del envío. Los precios serán F.C.A. Barcelona para pedidos superiores a 1.500€. Los pedidos inferiores a 1.500€ serán enviados ExWorks.
- 6**
De no existir otro acuerdo, las condiciones de pago serán:
-Letra de crédito irrevocable a la vista
-Transferencia por avanzado
-Contado contra documento
- 7**
INDUSTRIAS COSMIC, S.A.U. ofrece una garantía de 3 años, excepto en los casos indicados en la tarifa, contra todos los defectos de materia prima y fabricación válida a partir del momento de adquisición por parte del cliente final. A fin de determinar la fecha de adquisición será imprescindible la presentación de la factura de compra. Esta garantía consistirá en la sustitución de la pieza que determine su irregular funcionamiento, salvo por razones de uso inadecuado, montaje o instalación incorrectos, mantenimiento indebido, desgaste del uso diario o defectos provocados por reacciones químicas, electroquímicas o eléctricas. La garantía excluye de responsabilidad a INDUSTRIAS COSMIC, S.A.U. de todas las consecuencias derivadas del funcionamiento o instalación de nuestros productos y esta no reconoce ninguna indemnización por la sustitución de artículos defectuosos ni demanda por daños y perjuicios.
- 8**
INDUSTRIAS COSMIC, S.A.U. intenta siempre reducir al máximo los tiempos de servicio al cliente, ajustándose en lo posible a los requisitos de plazo solicitados expresamente en el pedido y, en caso de no poder satisfacerlos, se enviará una notificación.
- 9**
Los productos marca COSMIC, objeto de pedido, se entregarán bajo reserva de dominio a favor de INDUSTRIAS COSMIC, S.A.U. hasta el total cumplimiento de las obligaciones de pago por parte del comprador.
- 10**
En caso de impagados, se incurre en un cargo por devolución, más los gastos de financiación actuales en el mercado. INDUSTRIAS COSMIC, S.A.U. se reserva el derecho de retener los pedidos en curso hasta solucionar los efectos pendientes.
- 11**
Las disputas referentes a la interpretación o a la ejecución de estas condiciones generales de venta pasarán a ser competencia de los tribunales de nuestra jurisdicción.
- 12**
COSMIC aporta la Información de las certificaciones que cumplimos como fabricantes. Es responsabilidad de los instaladores conocer las certificaciones necesarias en cada país.



ART DIRECTION
COSMIC STUDIO

GRAPHIC DESIGN
AT COMUNICACIÓ

COSMIC

INDUSTRIAS COSMIC, S.A.U.
C/ESQUEIS S/N LOCAL 1
POL. IND. CAN BARRI
08415 BIGUES I RIELLS BARCELONA SPAIN
CENTRAL OFFICE TEL +34 938 654 277
INTERNATIONAL PHONE TEL +34 938 664 101
SHOWROOM C/ESQUEIS S/N LOCAL 1 POL. IND. CAN BARRI
08415 BIGUES I RIELLS BARCELONA SPAIN

info@icosmic.com
www.icosmic.com

PRINTING DATE: DECEMBER 2022
FECHA DE IMPRESIÓN: DICIEMBRE 2022

